

10

LLAVES DE VASO
SOCKET WRENCHES
DOUILLES
STECKSCHLÜSSEL
BUSSOLE
CHAVES DE CAIXA
ГОЛОВКИ

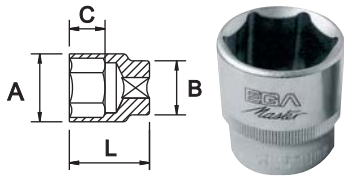

- 1/4"
- STANDARD
- MM



COD.	AF mm	L (mm)	A (mm)	B (mm)	C (mm)	Pt	g	Icon
61322	3,2		6		7			
61311	4		7		8			
63974	4,5					9		30
61312	5		8					
63975	5,5			12				
61313	6		9		9		10	
61314	7		11					
61315	8	25	12			6	12	25
61316	9		13				13	
61317	10		15	13			15	
61318	11		16	14			17	20
61319	12		17		13		20	
61320	13		18	15				
61321	14		17				23	

○ I DIN 3124

CARACTERÍSTICAS / FEATURES / CARACTÉRISTIQUES

Cr-V

- MM

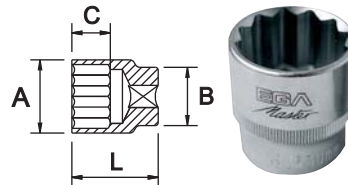

COD.	AF mm	L (mm)	A (mm)	B (mm)	C (mm)	Pt	g	Icon
63977	5		8				9	30
63978	5,5							
63979	6		9				10	
63980	7		11	12	9		12	25
63981	8		12					
63982	9	25	13			12	13	
63983	10		15	13			15	
63984	11		16	14			17	20
63985	12		17		13		20	
63986	13		18	15				
63987	14		17				23	

○ I DIN 3124

CARACTERÍSTICAS / FEATURES / CARACTÉRISTIQUES

Cr-V

- INCH

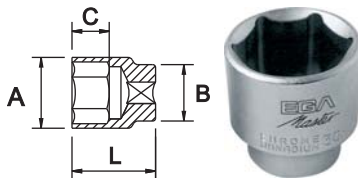

COD.	AF inch	L (mm)	A (mm)	B (mm)	C (mm)	Pt	g	Icon
60420	5/32		7		9	9		30
60421	3/16						10	
60422	7/32		9	12				
60423	1/4		9,5		11		12	25
60424	9/32		11				13	
60425	5/16	25	12			6		
60426	11/32		14	14			15	
60427	3/8				12		16	20
60428	7/16		16	16			21	
60429	1/2		18	18			27	
60430	9/16		20	20	13		34	

○ I DIN 3124

CARACTERÍSTICAS / FEATURES / CARACTÉRISTIQUES

Cr-V

- INCH

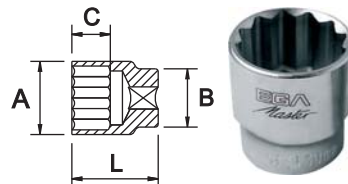

COD.	AF inch	L (mm)	A (mm)	B (mm)	C (mm)	Pt	g	Icon
63989	3/16		7		9	9		30
63990	7/32		9				10	
63991	1/4		9,5	12	11		12	25
63992	9/32		11				13	
63993	5/16	25	12			12		
63994	11/32		14	14			15	
63995	3/8				12		16	20
63996	7/16		16	16			21	
63997	1/2		18	18			27	
63998	9/16		20	20	13		34	

○ I DIN 3124

CARACTERÍSTICAS / FEATURES / CARACTÉRISTIQUES

Cr-V

x 50% cromado aeroespacial - 50% cromado pulido espejo / 50% aerospace chrome plating - 50% mirror polished chrome plating / 50% chromée aérospatiale - 50% polie chromée
y 100% cromado pulido espejo / 100% mirror polished chrome plating / 100% polie chromée

1/4"

SERIE LARGA / LONG SOCKETS / SÉRIE LONGUE / LANGE SERIE / SERIE LUNGA / SERIE LONGA / ВЫСОКАЯ СЕРИЯ

MM

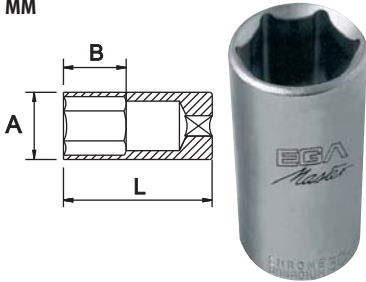

COD.	AF mm	L (mm)	A (mm)	B (mm)	Pt	g		
67640	4		7	10	20			
67641	4,5		8		21			
67642	5		9	11	23			
67643	5,5		10		24			
67644	6		11	14	26			
67645	7		12	19	27			
67646	x 8	50	13	20	37	6	10	•
67647	9		14		39			
67648	10		15	22	46			
67649	11		16	23	50			
67650	12		17		55			
67651	13		18	26	75			
67652	14		19					

DIN 3124

CARACTERÍSTICAS / FEATURES / CARACTÉRISTIQUES

Cr-V

INCH

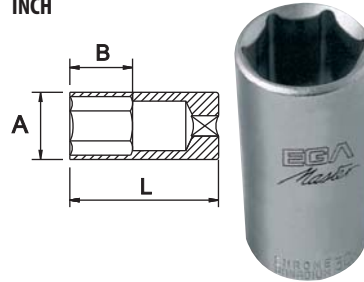

COD.	AF inch	L (mm)	A (mm)	B (mm)	Pt	g		
67674	5/32		7	8	22			
67675	3/16		8	11	24			
67676	7/32		9	14				
67677	1/4		9,5					
67678	9/32		11	18	28			
67679	y 5/16	50	12		30	6	10	
67680	11/32		13	20	44			
67681	3/8		16		45			
67682	7/16		16	22	55			
67683	1/2		20		70			
67684	9/16		20	26				

DIN 3124

CARACTERÍSTICAS / FEATURES / CARACTÉRISTIQUES

Cr-V

MM

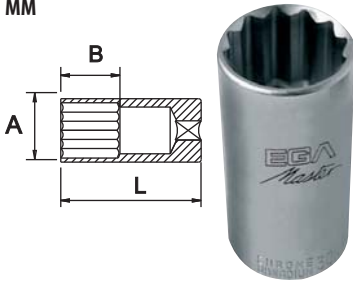

COD.	AF mm	L (mm)	A (mm)	B (mm)	Pt	g		
67660	5		8	11	23			
67661	5,5		9		24			
67662	6		9,5	14	26			
67663	7		11	19	27			
67664	8		12		37			
67665	x 9	50	13	20	39	12	10	•
67666	10		14		46			
67667	11		15	22	50			
67668	12		16	23	55			
67669	13		17		75			
67670	14		18					

DIN 3124

CARACTERÍSTICAS / FEATURES / CARACTÉRISTIQUES

Cr-V

INCH

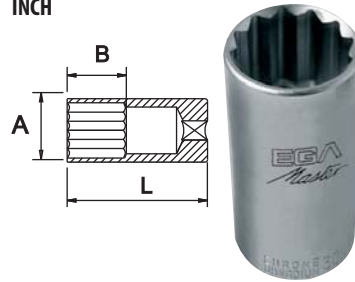

COD.	AF inch	L (mm)	A (mm)	B (mm)	Pt	g		
67689	5/32		7	8	22			
67690	3/16		8	11	24			
67691	7/32		9	14				
67692	1/4		9,5					
67693	9/32		11	18	28			
67694	y 5/16	50	12		30	12	10	•
67695	11/32		13	20	44			
67696	3/8		16		45			
67697	7/16		16	22	55			
67698	1/2		20		70			
67699	9/16		20	26				

DIN 3124

CARACTERÍSTICAS / FEATURES / CARACTÉRISTIQUES

Cr-V

x 50% cromado aeroespacial - 50% cromado pulido espejo / 50% aerospaceal chrome plating - 50% mirror polished chrome plating / 50% chromée aérospatiale - 50% polie chromée
y 100% cromado pulido espejo / 100% mirror polished chrome plating / 100% polie chromée

10

LLAVES DE VASO
SOCKET WRENCHES
DOUILLES
STECKSCHLÜSSEL
BUSSOLE
CHAVES DE CAIXA
ГОЛОВКИ



1/4"

TORX®*

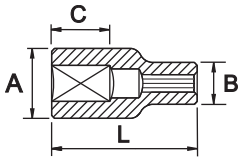

COD.		L (mm)	A (mm)	B (mm)	C (mm)			
57165	E4	25	7	12	6	11	25	●
57166	E5		8		8	12		
57167	E6		9		13	14		
57168	E7		10		14	16		
57169	E8		11					
57170	E10		13					



SPLINE

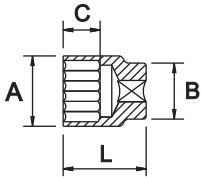

COD.					L (mm)	A (mm)	B (mm)	C (mm)					
56015	M5	5/32	4	E5	25	7	12	10	10	30	●		
56017	M6	-	5	E6		8							
56018	M7	7/32	5,5	-		8,5							
56019	-	-	6	-		9							
55813	-	1/4	-	-		10,5							
56020	M9	9/32	7	-		13							
56021	y M10	5/16	8	E10	13	13	10	14	25				
56023	-	-	10	-	20	16	16	23	25				
55814	-	3/8	-	-		16							
56024	M14	7/16	11	E14		18					18	27	20
56025	M15	-	12	E16		19					19	30	
56026	M16	1/2	13	-		20					20	33	
56027	M18	-	14	E18									

DIN 3120

CARACTERÍSTICAS / FEATURES / CARACTÉRISTIQUES

Cr-V

*Para tornillos TORX® (Marca registrada por Acument Intellectual Properties, LLC, Troy, Mich., US) / *For screws TORX® (Acument Intellectual Properties, LLC, Troy, Mich., US registered trademark) / **Pour vis TORX® (Marque enregistrée par Acument Intellectual Properties, LLC, Troy, Mich., US)

y 100% cromado pulido espejo / 100% mirror polished chrome plating / 100% polie chromée

10

**LLAVES DE VASO
SOCKET WRENCHES
DOUILLES
STECKSCHLÜSSEL
BUSSOLE
CHAVES DE CAIXA
ГОЛОВКИ**



1/4"

EXTRACTOR DE TUERCAS DESGASTADAS HASTA EL 50% / SCREW EXTRACTOR FOR 50% ROUNDED OFF NUTS / EXTRACTEUR D'ÉCROUS USÉS JUSQU'À 50% / AUSZIEHER 50% ABGENUTZTE MUTTER / ESTRATTORE PER DADI SPANATI FINO AL 50% / EXTRACTOR DE PORCAS DESGASTADAS ATÉ 50% / СЪЁМНИК ДЛЯ СВЕРНУТЫХ НА 50% ГАЕЕК

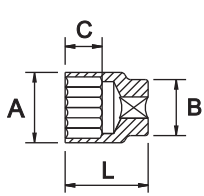

COD.	AF mm	L (mm)	A (mm)	B (mm)	C (mm)	g	Icon	Icon
56015	4			7				
56017	5			8				
56018	5,5		12	8,5		10		30
56019	6			9				
56020	7			10,5				
56021	8	25	13	13	10	14		25
56023	10		16	16		23		
56024	11							
56025	12		18	18		27		20
56026	13		19	19		30		
56027	14		20	20		33		

DIN 3120

CARACTERÍSTICAS / FEATURES / CARACTÉRISTIQUES

Cr-V

LLAVES DE VASO ARTICULADAS / UNIVERSAL SOCKET / DOUILLES ARTICULÉES / STECKSCHLÜSSELGELENK / CHIAVE A BUSSOLA ARTICOLATA / CHAVES DE CAIXA ARTICULADAS / УНИВЕРСАЛЬНАЯ ГОЛОВКА С ШАРНИРОМ

MM

INCH



COD.	AF mm	L (mm)	g	Icon	Icon
57279	6				
57280	7				
57281	8	34	23		
57282	9				
57283	10			10	•
57284	11				
57285	12	37	56		
57286	13				
57287	14				

COD.	AF inch	L (mm)	g	Icon	Icon
57288	1/4				
57289	5/16	34	23		
57290	3/8			10	•
57291	7/16	37	56		
57292	1/2				

y 100% cromado pulido espejo / 100% mirror polished chrome plating / 100% polie chromée

x 50% cromado aeroespacial - 50% cromado pulido espejo / 50% aerospaceal chrome plating - 50% mirror polished chrome plating / 50% chromée aérospatiale - 50% polie chromée





Si no encuentra el artículo que necesita, consúltenos en info@egamaster.com o en www.egamaster.com
If you can't find the item you look for, please ask us in info@egamaster.com or in www.egamaster.com
Si vous ne trouvez pas l'article que vous desirez, consultez-nous a info@egamaster.com ou a www.egamaster.com

EGA Master
ART IN INNOVATION

1/4"





PUNTAS ATORNILLADORAS CON VASO / SOCKET BITS / EMBOUTS DE VISSAGE AVEC DOUILLE / STECKSCHLÜSSELEINSATZ / INSERTI A BUSSOLA / PONTAS APARAFUSADORAS COM CAIXA / ГОЛОВКИ-БИТЫ

■ PLANA / FLAT / À FENTE / FLACH / PIATTA / PLANA / ПЛОСКАЯ

COD.		L (mm)			
66733	0,8 x 4	37	15	10	●
66734	1 x 5,5				
66735	1,2 x 6,5				
66736	1,2 x 8				







■ PHILIPS

COD.		L (mm)			
66737	PH-1	37	15	10	●
66738	PH-2				
66739	PH-3				







■ POZIDRIV**

COD.		L (mm)			
66740	PZ-1	37	15	10	●
66741	PZ-2				
66742	PZ-3				







■ HEXAGONAL / HEXAGONAL / HEXAGONALE / HEXAGONAL / ESAGONALE / HEXAGONAL / ШЕСТИГРАННАЯ

■ MM

COD.		L (mm)			
55697	1,5	37	15	10	●
55698	2				
66743	3				
55699	3,5				
66744	4				
66745	5				
55700	5,5				
66746	6				
66747	8				



■ INCH

COD.		L (mm)			
55670	1/16	37	15	10	●
55671	5/64				
55672	3/32				
55673	7/64				
55674	1/8				
55675	9/64				
55676	5/32				
55677	3/16				
55678	7/32				
55679	1/4				



1/4"

■ TORX®*

COD.		L (mm)			
66729	T-6			15	
66730	T-7				
66748	T-8				
66749	T-9				
66750	T-10				
66751	T-15	37	15		●
66752	T-20			10	
66753	T-25				
66754	T-27				
66755	T-30				
66756	T-40				



■ SET

COD.		inch	PCS.			COD. PCS.	Composición / Composition / Composition
66757			12	250		66733, 66734, 66735, 66736, 66737, 66738, 66739, 66743, 66744, 66745, 66746, 66747	0,8 x 4 - 1 x 5,5 - 1,2 x 6,5 - 1,2 x 8 mm - PH-1 - PH-2 - PH-3 - HEX-3 - HEX-5 - HEX-6 - HEX-8 -
66758	1/4				1	66733, 66734, 66735, 66736, 66740, 66741, 66742, 66743, 66744, 66745, 66746, 66747	0,8 x 4 - 1 x 5,5 - 1,2 x 6,5 - 1,2 x 8 mm - PZ-1 - PZ-2 - PZ-3 - HEX-3 - HEX-4 - HEX-5 - HEX-6 - HEX-8 -
66759			9	200		66748, 66749, 66750, 66751, 66752, 66753, 66754, 66755, 66756	T-8 - T-9 - T-10 - T-15 - T-20 - T-25 - T-27 - T-30 - T-40



■ ADAPTADOR / ADAPTER / ADAPTATEUR / VERBINDUNGSTEIL / ADATTATORE / REDUTOR / АДАПТЕР

COD.		inch		inch			
65880		1/4-3/8			15	6	●



*Para tornillos TORX® (Marca registrada por Acument Intellectual Properties, LLC, Troy, Mich., US) / *For screws TORX® (Acument Intellectual Properties, LLC, Troy, Mich., US registered trademark) / *Pour vis TORX® (Marque enregistrée par Acument Intellectual Properties, LLC, Troy, Mich., US)

1/4"

LLAVE FIJA CROW FOOT / OPEN END CROW FOOT WRENCH / CLÉ À FOURCHE CROW FOOT / EINSTECK-MAULSCHLÜSSEL / CHIAVE FISSA CROW FOOT / PONTEIRA DE BOCA COM QUADRADO INTERIOR / РОЖКОВЫЙ КЛЮЧ С КВАДРАТОМ

■ MM

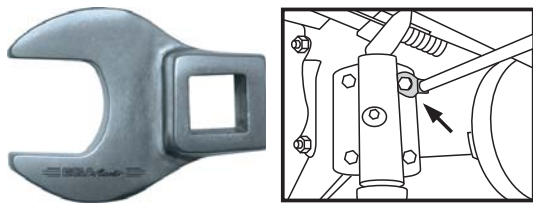
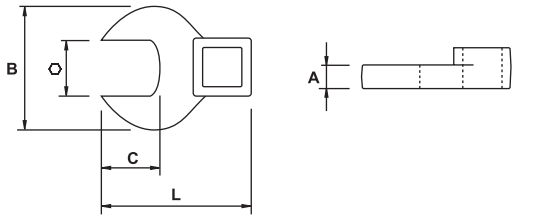

■ INCH

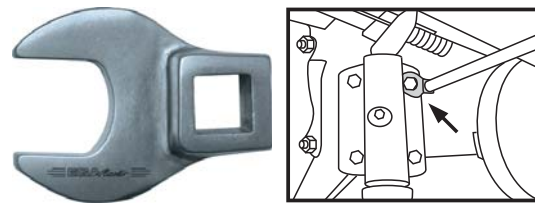
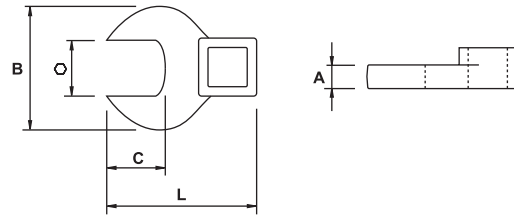

COD.	AF mm	L (mm)	A (mm)	B (mm)	C (mm)	g	PC	CS
57211	7	30		25	6	70		
57212	8	31	6	26	7			
57213	9	33		28	8	75		
57214	10	35		30	9	10	•	
57215	11	36		31	11	90		
57216	12	38	7	34	12	95		
57217	13	39		35	13			

COD.	AF inch	L (mm)	A (mm)	B (mm)	C (mm)	g	PC	CS
57218	5/16	31		26	7	70		
57219	3/8	33	6	28	8	75		
57220	7/16	35		30	9	10	•	
57221	1/2	38		34	12	92		
57222	9/16	39	7	36	14	100		

DESTORNILLADOR PORTAVASOS 1/4" / 1/4" SOCKET HOLDER / TOURNEVIS PORTE-DOUILLE 1/4" / 1/4" STECKSCHLÜSSEL-HALTER / CACCIAVITE PORTA BUSSOLA 1/4" / APARAFUSADOR PORTA CHAVES CAIXA 1/4" / 1/4" ДЕРЖАТЕЛЬ ГОЛОВКИ

COD.	AF inch	L (mm)	g	PC	CS
66732	1/4	180	95	6	•



DESTORNILLADOR PORTAPUNTAS MAGNÉTICO / MAGNETIC BITHOLDER SCREWDRIVER / TOURNEVIS PORTE-EMBOUTS MAGNÉTIQUE / MAGNETISCHER BITHALTER-SCHRAUBENDREHER / CACCIAVITE PORTA INSERTI MAGNETICOM / CHAVE PORTA PONTAS MAGNETICO / ОТВЕРТКА С МАГНИТНЫМ БИТОДЕРЖАТЕЛЕМ

COD.	inch	L (mm)	g	PC	CS
66731	1/4	215	105	6	•



COD.	inch	L (mm)	g	PC	CS
76737	1/4	210	120	6	•



1000V I IEC 60900

PUNTA HEXAGONAL / HEXAGONAL BIT / EMBOUT HEXAGONAL / SECHSKANT EINSATZ / INSERTO ESAGONALE / PONTEIRA HEXAGONAL / БИТА ШЕСТИГРАННАЯ

COD.	inch	L (mm)	PCS
55941	1/4	50	5



1/4"

1/4"

LLAVE DE CARRACA REVERSIBLE / REVERSIBLE RATCHET HANDLE / CLÉ À CLIQUET RÉVERSIBLE / UMSCHALTKNARRE / CHIAVE A CRICCO REVERSIBILE / ROQUETE REVERSIVEL / РЕВЕРСИВНАЯ ТРЕЩЕТКА

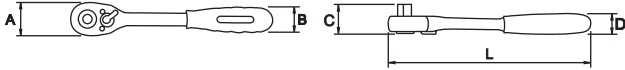

COD.	AF inch	L (mm)	A (mm)	B (mm)	C (mm)	D (mm)	g	Icon	Icon
61428	1/4	150	28	21	21	15	105	6	●

DIN 3122

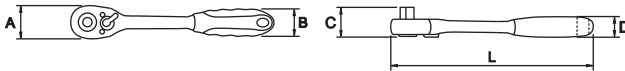
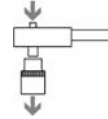

COD.	AF inch	L (mm)	A (mm)	B (mm)	C (mm)	D (mm)	g	Icon	Icon
62603	1/4	140	23	21	22	17	105	6	●

DIN 3122

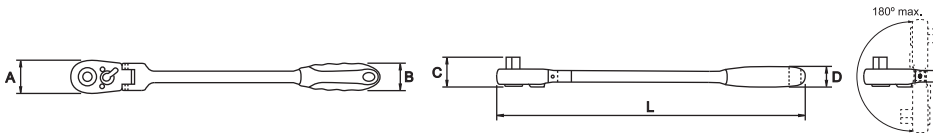
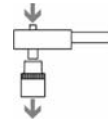

COD.	AF inch	L (mm)	A (mm)	B (mm)	C (mm)	D (mm)	g	Icon	Icon
57411	1/4	160	22	21	23	17	120	6	●

DIN 3122

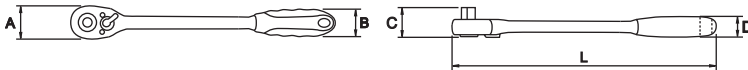

COD.	AF inch	L (mm)	A (mm)	B (mm)	C (mm)	D (mm)	g	Icon	Icon
57414	1/4	180	23	21	21	17	150	6	●

DIN 3122



MANGO CORREDIZO EN "T" / SLIDING "T" HANDLE / POIGNEE COULISSANTE / QUERGRIF / ASTA CON QUADRO SCORREVOLO / CABO "T" CORREDIÇO / ПОДВИЖНАЯ "Т" РУЧКА

COD.	AF inch	L (mm)	g	Icon	Icon
61438	1/4	115	60	5	●

DIN 3122



ARTICULACIÓN UNIVERSAL / UNIVERSAL JOINT / CARDAN UNIVERSEL / KARDANGELNENK / SNODO CARDANICO / CARDAN UNIVERSAL / ШАРНИР

COD.	AF inch	g	Icon	Icon
61435	1/4	30	10	●

DIN 3123



1/4"

■ ALARGADERA / EXTENSION / RALLONGE / VERLÄNGERUNG / PROLUNGA / EXTENÇÃO / УДЛИНИТЕЛЬ

COD.	AF inch	L (inch)	g		
61442	1/4	2	25	5	●
61454		3	35		
61443		4	45		
61444		6	65		
62731		10	110		

DIN 3123



■ ALARGADERA FLEXIBLE / FLEXIBLE HANDLE / RALLONGE FLEXIBLE / GELENK-STECKGRIFF / PROLUNGA FLESSIBILE / EXTENSÃO FLEXÍVEL / ГИБКАЯ РУКОЯТКА

COD.	AF inch	L (inch)	g		
61445	1/4	6	60	5	●

DIN 3122



■ MANGO ARTICULADO / SWIVEL HANDLE / MANCHE ARTICULÉ / GELENKGRIF / IMPUGNATURA SNODABILE / CABO ARTICULADO / РУЧКА С ШАРНИРОМ

COD.	AF inch	L (mm)	g		
65874	1/4	150	260	5	●



EGGA *Master*
ART IN INNOVATION

■ 3/8"

■ STANDARD

■ MM

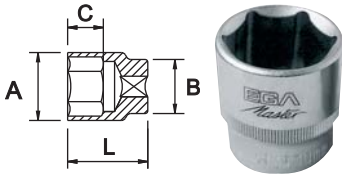

■ MM

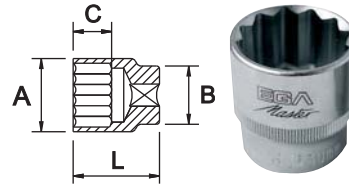

COD.	AF mm	L (mm)	A (mm)	B (mm)	C (mm)	Pt	g	Icon
67541	6		10			9	20	
67542	7		11					
67543	8		12				24	
67544	9		14					25
67545	10		15	17				
67546	11		16		10		25	
67547	12		18				28	
67548	13		20				32	20
67549	14	28	20	18		12	32	
67550	15		21	19			48	15
67551	16		22	21		14		
67552	17		24	22				12
67553	18		25	22			55	
67554	19		26		15			
67555	20		28				80	
67556	21		30	26				10
67557	22		32	28	17		100	
67558	23							
67559	24	32	32	28	17		100	

COD.	AF mm	L (mm)	A (mm)	B (mm)	C (mm)	Pt	g	Icon
67539	6		10			9	20	
67540	7		11					
61343	8		12					
61344	9		14				24	25
61345	10		15	17				
61346	11		16		10		25	
61347	12		18				28	
61348	13		20				32	20
61349	14	28	20	18		12	32	
61350	15		21	19			48	15
61351	16		22	21		14		
61352	17		24	22				12
61353	18		25	22			55	
61354	19		26		15			
61355	20		28				80	
61356	21		30	26				10
67560	22		32	28	17		100	
67561	24	32	32	28	17		100	

○ I DIN 3124

○ I DIN 3124

CARACTERÍSTICAS / FEATURES / CARACTÉRISTIQUES

Cr-V

CARACTERÍSTICAS / FEATURES / CARACTÉRISTIQUES

Cr-V

x 50% cromado aeroespacial - 50% cromado pulido espejo / 50% aerospaceal chrome plating - 50% mirror polished chrome plating / 50% chromée aérospatiale - 50% polie chromée

Si no encuentra el artículo que necesita, consúltenos en info@egamaster.com o en www.egamaster.com
If you can't find the item you look for, please ask us in info@egamaster.com or in www.egamaster.com
Si vous ne trouvez pas l'article que vous desirez, consultez-nous a info@egamaster.com ou a www.egamaster.com

3/8"

INCH

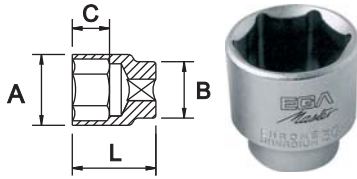

COD.	AF inch	L (mm)	A (mm)	B (mm)	C (mm)	Pt	g	
67620	1/4		11					
67621	9/32					22		
67622	5/16		12	17				25
67623	11/32	28	13		10	6	24	
67624	3/8		15				26	
67625	7/16		16				30	
67626	1/2		18	18				20
67627	9/16		20		12		31	

DIN 3124

CARACTERÍSTICAS / FEATURES / CARACTÉRISTIQUES

Cr-V

INCH

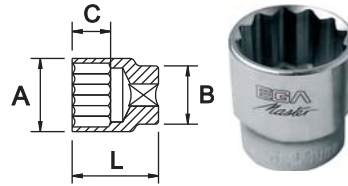

COD.	AF inch	L (mm)	A (mm)	B (mm)	C (mm)	Pt	g	
60439	1/4		11					22
60440	5/16		12					25
60441	11/32		13	17			24	
60442	3/8		15		10		26	
60443	7/16	28	16				30	
60444	1/2		18	18				20
60445	9/16		20				31	
60446	19/32		21	19	12	12	35	15
60447	5/8		22		13		45	
60448	11/16		24	23			50	12
60449	3/4	30	26	24			60	
60450	13/16		28		17		75	
60451	7/8		30	28			80	10
60452	15/16	32	32				90	
60453	1		34	30	20		100	

DIN 3124

CARACTERÍSTICAS / FEATURES / CARACTÉRISTIQUES

Cr-V

3/8"

SERIE LARGA / LONG SOCKETS / SÉRIE LONGUE / LANGE SERIE / SERIE LUNGA / SERIE LONGA / ВЫСОКАЯ СЕРИЯ

■ MM

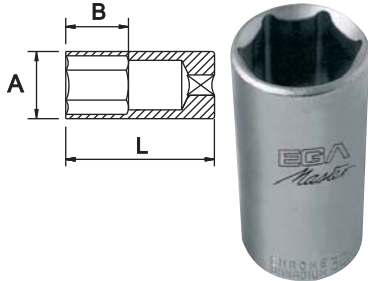

COD.	AP mm	L (mm)	A (mm)	B (mm)	Pt	g	Icon 1	Icon 2
67705	7		11			41		
67706	8		12	16		42		
67707	9		13	18		50		
67708	10		15	20		55		
67709	11		17	24		70		
67710	12		19	25		80		
67711	13		20	27		85		
67712	x 14	65	21		6	105	10	•
67713	15		22			130		
67714	16		24			150		
67715	17		26	28		160		
67716	18		28			200		
67717	19		30	30				
67719	21							
67720	22							

○ I DIN 3124

CARACTERÍSTICAS / FEATURES / CARACTÉRISTIQUES

Cr-V

■ MM

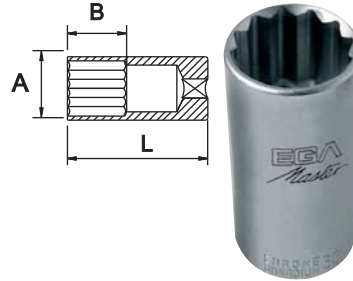

COD.	AP mm	L (mm)	A (mm)	B (mm)	Pt	g	Icon 1	Icon 2
67725	7		11			41		
67726	8		12	16		42		
67727	9		13	18		50		
67728	10		15	20		55		
67729	11		17	24		70		
67730	12		19	25		80		
67731	13		20	27		85		
67732	x 14	65	21		12	105	10	•
67733	15		22			130		
67734	16		24			150		
67735	17		26	28		160		
67736	18		28			200		
67737	19		30	30				
67738	20							
67739	21							
67740	22							

○ I DIN 3124

CARACTERÍSTICAS / FEATURES / CARACTÉRISTIQUES

Cr-V

■ INCH

COD.	AP inch	L (mm)	A (mm)	B (mm)	Pt	g	Icon 1	Icon 2
67750	1/4		11	17		49		
67751	5/16		12	22		50		
67752	3/8		15	23		60		
67753	7/16		16	26		75		
67754	1/2		19	26		80		
67755	9/16		20	27		90		
67756	y 19/32	65	21		12	100	10	•
67757	5/8		22			135		
67758	11/16		26	28		165		
67759	3/4		28			190		
67760	13/16		30	30		230		
67761	7/8							
67762	15/16							

○ I DIN 3124

CARACTERÍSTICAS / FEATURES / CARACTÉRISTIQUES

Cr-V

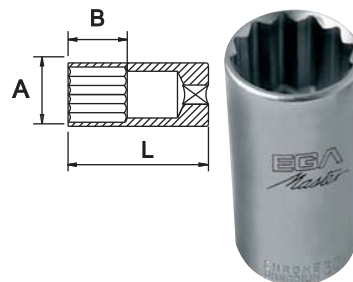

y 100% cromado pulido espejo / 100% mirror polished chrome plating / 100% polie chromée
x 50% cromado aeroespacial - 50% cromado pulido espejo / 50% aerospaceal chrome plating - 50% mirror polished chrome plating / 50% chromée aérospatiale - 50% polie chromée

3/8"

TORX®*

COD.		L (mm)	A (mm)	B (mm)	C (mm)			
57171	E8	28	12	17	10	25		
57172	E10		15			30		
57173	E11		16	18		38		
57174	E12							
57175	E14		22	19		51		
57176	E16							
57177	E18		29	10				
57178	E20		30	21		10		



LLAVES DE VASO ARTICULADAS / UNIVERSAL SOCKET / DOUILLES ARTICULÉES / STECKSCHLÜSSELGELENK / CHIAVE A BUSSOLA ARTICOLATA / CHAVES DE CAIXA ARTICULADAS / УНИВЕРСАЛЬНАЯ ГОЛОВКА С ШАРНИРОМ

MM



INCH



COD.		L (mm)			
57293	10	45	55		
57294	11	47	57		
57295	12		59		
57296	13	61			
57297	15		71		
57298	17	50			
57299	18		76		
57300	19				





COD.		L (mm)			
57301	3/8	46	55		
57302	7/16		57		
57303	1/2	47	59		
57304	9/16		10		
57305	5/8	49			
57306	11/16	50	76		
57307	3/4	51			



* Para tornillos TORX® (Marca registrada por Acument Intellectual Properties, LLC, Troy, Mich., US) / *For screws TORX® (Acument Intellectual Properties, LLC, Troy, Mich., US registered trademark) / *Pour vis TORX® (Marque enregistrée par Acument Intellectual Properties, LLC, Troy, Mich., US)
 x 50% cromado aeroespacial - 50% cromado pulido espejo / 50% aerospace chrome plating - 50% mirror polished chrome plating / 50% chromée aérospatiale - 50% polie chromée
 y 100% cromado pulido espejo / 100% mirror polished chrome plating / 100% polie chromée

3/8"





■ TORX®*

COD.		L (mm)			
57308	E8	46	56	10	●
57309	E10				
57310	E12				
57311	E14				
57312	E16				







■ PUNTAS ATORNILLADORAS CON VASO / SOCKET BITS / EMBOUTS DE VISSAGE AVEC DOUILLE / STECKSCHLÜSSELEINSATZ / INSERTI A BUSSOLA / PONTAS APARAFUSADORAS COM CAIXA / ГОЛОВКИ-БИТЫ

■ PLANA / FLAT / À FENTE / FLACH / PIATTA / PLANA / ПЛОСКАЯ

COD.		L (mm)			
66760	1 x 5,5	48	35	10	●
66761	1,2 x 6,5				
66762	1,2 x 8				
66763	1,5 x 8				
66764	1,6 x 10				







■ PHILIPS

COD.		L (mm)			
66765	PH-1	48	35	10	●
66766	PH-2				
66767	PH-3				







■ POZIDRIV®*

COD.		L (mm)			
66768	PZ-1	48	35	10	●
66769	PZ-2				
66770	PZ-3				



■ HEXAGONAL / HEXAGONAL / HEXAGONALE / HEXAGONAL / ESAGONALE / HEXAGONAL / ШЕСТИГРАННАЯ

■ MM

COD.		L (mm)			
66771	3	48	35	10	●
55701	3,5				
66772	4				
66773	5				
55702	5,5				
66774	6				
66775	7				
66776	8				
55703	9,5				
66777	10				







* Para tornillos TORX® (Marca registrada por Acument Intellectual Properties, LLC, Troy, Mich., US) / *For screws TORX® (Acument Intellectual Properties, LLC, Troy, Mich., US registered trademark) / *Pour vis TORX® (Marque enregistrée par Acument Intellectual Properties, LLC, Troy, Mich., US)

y 100% cromado pulido espejo / 100% mirror polished chrome plating / 100% polie chromée

* Para tornillos POZIDRIV® (Marca registrada por European Ind. Serv. Ltd.) / *For screws POZIDRIV® (European Ind. Serv. Ltd. registered trademark) / *Pour vis POZIDRIV® (Marque enregistrée par European Ind. Serv. Ltd.)

3/8"





INCH

COD.		L (mm)			
55680	1/8				
55681	9/64				
55682	5/32				
55683	3/16	48	35	10	•
55684	7/32				
55685	1/4				
55686	5/16				
55687	3/8				



HEXAGONAL SERIE LARGA / HEXAGONAL LONG / HEXAGONALE SÉRIE LONGUE / HEXAGONAL LANG / ESAGONALO SERIE LUNGO / HEXAGONAL SÉRIE LONGA / ШЕСТИГРАННАЯ ВЫСОКАЯ





MM

COD.		L (mm)			
66778	4				
66779	5				
66780	6	92	70	10	•
66781	8				
66782	10				







INCH

N!

COD.		L (mm)			
56975	1/8		90		
56976	9/64				
56977	5/32		95		
56978	3/16		100	10	•
56979	7/32	100	110		
56980	1/4		115		
56981	5/16		170		
56982	3/8		235		







HEXAGONAL PUNTA DE BOLA SERIE LARGA / HEXAGONAL BALL POINT LONG SERIE / HEXAGONALE EMBOUT SPHÉRIQUE SÉRIE LONGUE / HEXAGONAL KUGELKOPF LANG / ESAGONALE TESTA SFERICA SERIE LUNGO / HEXAGONAL PONTA ESFERICA SÉRIE LONGA / ШЕСТИГРАННАЯ С ШАРОВОЙ ГОЛОВКОЙ ДЛИННАЯ

COD.		L (mm)			
66783	4				
66784	5				
66785	6	92	70	10	•
66786	8				
66787	10				



TORX®*

COD.		L (mm)			
66788	T-10				
66789	T-15				
66790	T-20				
66791	T-25				
66792	T-27	48	35	10	•
66793	T-30				
66794	T-40				
66795	T-45				



* Para tornillos TORX® (Marca registrada por Acument Intellectual Properties, LLC, Troy, Mich., US) / *For screws TORX® (Acument Intellectual Properties, LLC, Troy, Mich., US registered trademark) / *Pour vis TORX® (Marque enregistrée par Acument Intellectual Properties, LLC, Troy, Mich., US)

10

LLAVES DE VASO
SOCKET WRENCHES
DOUILLES
STECKSCHLÜSSEL
BUSSOLE
CHAVES DE CAIXA
ГОЛОВКИ



3/8"

COD.		L (mm)			
66796	T-50	48	35	10	●

SET

COD.		PCS.			COD. PCS.	Composición / Composition / Composition
66797	3/8	11	450	1	66760, 66761, 66762, 66763, 66764, 66765, 66766, 66767, 66768, 66769, 66770	1 x 5,5 - 1,2 x 6,5 - 1,2 x 8 - 1,5 x 8 - 1,6 x 10 mm - PH-1 - PH-2 - PH-3 - PZ-1 - PZ-2 - PZ-3
66798		12	650		66771, 66772, 66773, 66774, 66775, 66776, 66777, 66778, 66779, 66780, 66781, 66782	HEX-3 - HEX-4 - HEX-5 - HEX-6 - HEX-7 - HEX-8 - HEX-10 - HEX-4(L) - HEX-5(L) - HEX-6(L) - HEX-8(L) - HEX-10(L)
66799		12	650		66771, 66772, 66773, 66774, 66775, 66776, 66777, 66783, 66784, 66785, 66786, 66787	HEX-3 - HEX-4 - HEX-5 - HEX-6 - HEX-7 - HEX-8 - HEX-10 - HEX-4(L-B) - HEX-5(L-B) - HEX-6(L-B) - HEX-8(L-B) - HEX-10(L-B)
66800		9	350		66788, 66789, 66790, 66791, 66792, 66793, 66794, 66795, 66796	T-10 - T-15 - T-20 - T-25 - T-27 - T-30 - T-40 - T-45 - T-50



ADAPTADOR / ADAPTER / ADAPTATEUR / VERBINDUNGSTEIL / ADATTATORE / REDUTOR / АДАПТЕР

COD.					
65884	3/8-1/4		20	6	●
65881	3/8-1/2		45		



LLAVES DE VASO PARA BUJÍAS / SPARK PLUG SOCKETS / DOUILLES POUR BOUGIES / ZÜNDKERZEN - STECKSCHLÜSSEL / CHIAVI PER CANDELE / CHAVES DE CAIXA PA VELAS / ГОЛОВКИ ДЛЯ СВЕЧЕЙ ЗАЖИГАНИЯ

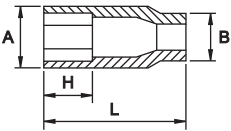

COD.			L (mm)	A (mm)	B (mm)	H (mm)			
61460	3/8	16	65	22	19	17	100	6	●
61461		21		28	22	20	150		



3/8"

LLAVE FIJA CROW FOOT / OPEN END CROW FOOT WRENCH / CLÉ À FOURCHE CROW FOOT / EINSTECK-MAULSCHLÜSSEL / CHIAVE FISSA CROW FOOT / PONTEIRA DE BOCA COM QUADRADO INTERIOR / РОЖКОВЫЙ КЛЮЧ С КВАДРАТОМ

MM

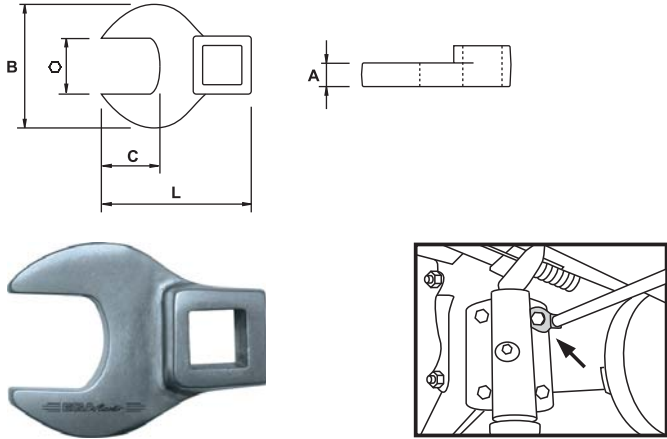

INCH

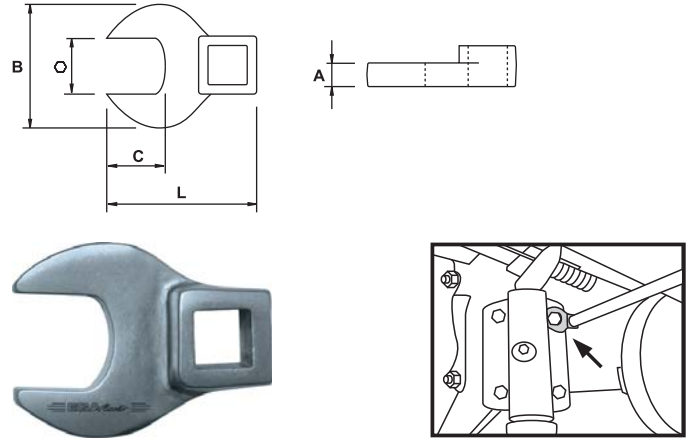

COD.	AF mm	L (mm)	A (mm)	B (mm)	C (mm)	g	Icons
55710	10	36	6	24	10	28	
55711	11	39	6,5	26	13		
55712	12	40	7,2	28	14	40	
55713	13	42	8,3	30	15	41	
55714	14	46	8,4	34	17	50	10 •
55715	15	48	8,8	36	18	56	
55716	16	50	9	40	21	62	
55717	17	55	9,5	46	22,5	80	
55718	19	65	10	54	25,5	140	

COD.	AF inch	L (mm)	A (mm)	B (mm)	C (mm)	g	Icons
55724	3/8	36	6	24	10	28	
55725	7/16	39	6,5	26	13		
55726	1/2	40	7,2	28	14	40	
55727	9/16	42	8,3	30	15	41	
55728	5/8	46	8,4	34	17	50	10 •
55729	11/16	48	8,8	36	18	56	
55730	3/4	50	9	40	21	62	
55731	13/16	55	9,5	46	21,5	80	
55732	7/8	65	10	54	22,5	100	
55733	15/16	65	10	54	25,5	140	

EGGA *Master*
ART IN INNOVATION

3/8"

LLAVE HEXAGONAL CROW FOOT / HEXAGONAL CROW FOOT WRENCH / CLÉ MÂLE CROW FOOT / SECHSKANT-EINSTECK-MAULSCHLÜSSEL / CHIAVE ESAGONALE CROW FOOT / PONTEIRA HEXAGONAL COM QUADRADO INTERIOR / РОЖКОВЫЙ ШЕСТИГРАННЫЙ КЛЮЧ С КВАДРАТОМ

MM

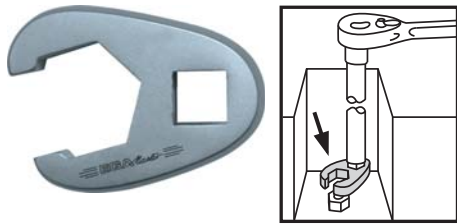
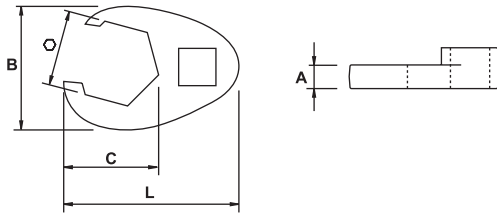

INCH

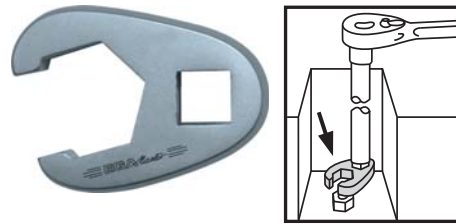
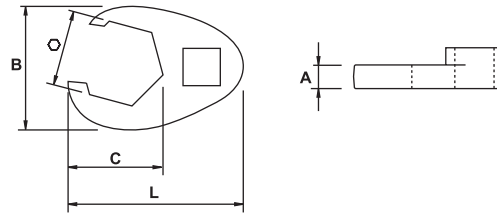

COD.	AF mm	L (mm)	A (mm)	B (mm)	C (mm)	g		
55736	10		7,8		16	28		
55737	11	38		31		18		
55738	12		8		18	35		
55739	13					40		
55740	14					41		
55741	15	41	9	33	21	50	10	•
55742	16					50		
55743	17	45	10,5	36	24	56		
55744	19	46			25	62		
55745	21					80		
55746	22	50	11	40	28,5	100		

COD.	AF inch	L (mm)	A (mm)	B (mm)	C (mm)	g		
55750	3/8		7,8		16	28		
55751	7/16	38		31		18		
55752	1/2		8		18	40		
55753	9/16					41		
55754	5/8	41	9	33	21	50	10	•
55755	11/16	46	10,5	36	24	56		
55756	3/4				25	62		
55757	13/16	50	11	40	28,5	80		
55758	7/8					100		

ADAPTADOR DE PAR / TORQUE ADAPTER / ADAPTATEUR DE COUPLE / DREHMOMENT ADAPTOR / ADATTATORE DI COPPIA / ADAPTADOR DE PAR / АДАПТЕР КРУТЯЩЕГО МОМЕНТА

MM

COD.	L (mm)	AF mm	AF inch	A (mm)	B (mm)	C (mm)	D (mm)	E (mm)	g		
57315		8							51		
57316	72,5	10	3/8	20	19	9	12	52	61	10	•
57317		13		24		11,5					



INCH

COD.	L (mm)	AF mm	AF inch	A (mm)	B (mm)	C (mm)	D (mm)	E (mm)	g		
57318		5/16									
57319		3/8		20		9		51			
57320	72,5	7/16	3/8		19		12	52	61	10	•
57321		1/2		24		12					
57322		9/16									

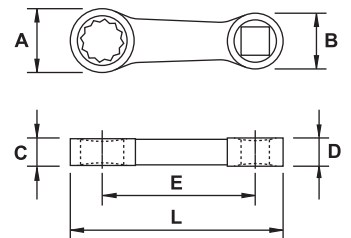

SPLINE

COD.	L (mm)	AF inch	AF inch	Spline	A (mm)	B (mm)	C (mm)	D (mm)	E (mm)	g		
57323		7/32		M7								
57324		1/4		M8								
57325	72,5	9/32	3/8	M9	20	19	9	12	52	51	10	•
57326		5/16		M10								

3/8"

COD.	L (mm)	AF inch	A (mm)	B (mm)	C (mm)	D (mm)	E (mm)	g	Icon 1	Icon 2
57327	72,5	3/8	M12	20	9	12	52	10	●	
57328		7/16	M14							
57329		1/2	M16	19						
57330		9/16	M18	24	12		61			
57331		5/8	M20							

LLAVE DE CARRACA REVERSIBLE / REVERSIBLE RATCHET HANDLE / CLÉ À CLIQUET RÉVERSIBLE / UMSCHALTKNARRE / CHIAVE A CRICCO REVERSIBILE / ROQUETE REVERSIVEL / РЕВЕРСИВНАЯ ТРЕЩЕТКА

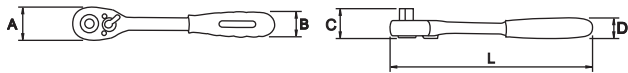

COD.	AF inch	L (mm)	A (mm)	B (mm)	C (mm)	D (mm)	g	Icon 1	Icon 2
61429	3/8	200	33	28	29	18	270	6	●

DIN 3122

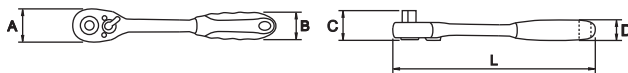
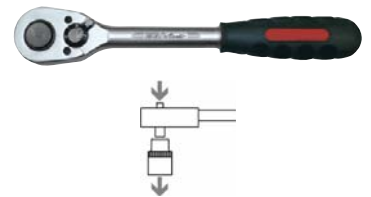

COD.	AF inch	L (mm)	A (mm)	B (mm)	C (mm)	D (mm)	g	Icon 1	Icon 2
62604	3/8	200	31	28	29	22	270	6	●

DIN 3122

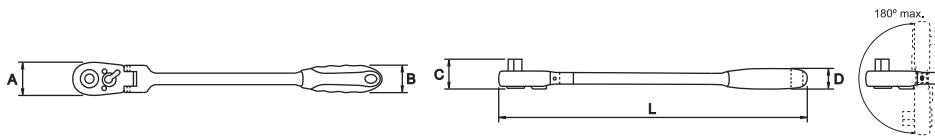
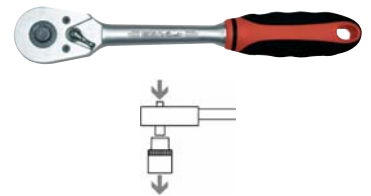

COD.	AF inch	L (mm)	A (mm)	B (mm)	C (mm)	D (mm)	g	Icon 1	Icon 2
57412	3/8	300	29	28	30	22	390	6	●

DIN 3122

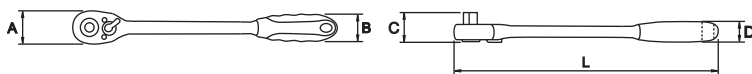

COD.	AF inch	L (mm)	A (mm)	B (mm)	C (mm)	D (mm)	g	Icon 1	Icon 2
57415	3/8	280	31	28	29	22	370	6	●

DIN 3122



MANGO CORREDIZO EN "T" / SLIDING "T" HANDLE / POIGNEE COULISSANTE / QUERGRIF / ASTA CON QUADRO SCORREVOLO / CABO "T" CORREDIÇO / ПОДВИЖНАЯ "Т" РУЧКА

COD.	AF inch	L (mm)	g	Icon 1	Icon 2
61439	3/8	165	180	5	●

DIN 3122



ARTICULACIÓN UNIVERSAL / UNIVERSAL JOINT / CARDAN UNIVERSEL / KARDANGELNENK / SNODO CARDANICO / CARDAN UNIVERSAL / ШАРНИР

COD.	AF inch	g	Icon 1	Icon 2
61436	3/8	80	10	●

DIN 3123



3/8"

■ ALARGADERA / EXTENSION / RALLONGE / VERLÄNGERUNG / PROLUNGA / EXTENÇÃO / УДЛИНИТЕЛЬ

COD.	AF inch	L (inch)	g		
62732	3/8	2	50	5	●
61459		3	65		
61447		6	120		
61449		8	175		
61450		10	240		

DIN 3123



■ BERBIQUÍ / SPEEDER HANDLE / VILLEBREQUIN / KURBEL / LEVA GIROBECCHINO / MANIVELA / КОЛЕНЧАТАЯ РУЧКА

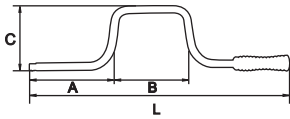

COD.	AF inch	L (mm)	A (mm)	B (mm)	C (mm)	g	
61409	3/8	425	130	140	115	570	5

DIN 3122



■ MANGO ARTICULADO / SWIVEL HANDLE / MANCHE ARTICULÉ / GELENKGRIF / IMPUGNATURA SNODABILE / CABO ARTICULADO / РУЧКА С ШАРНИРОМ

COD.	AF inch	L (mm)	g		
65875	3/8	214	375	5	●



BE SAFE... BE EFFICIENT

■ 1/2"

■ STANDARD

■ MM

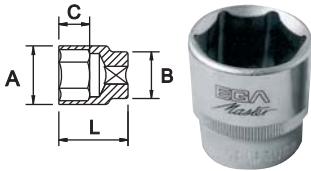

COD.	AF mm	L (mm)	A (mm)	B (mm)	C (mm)	Pt	g	Icon
61800	8		13				48	
61801	9		14		13		49	
61802	10		15				49	
61803	11		17					
61804	12		18	22			50	25
61805	13		19					
61806	14		20					
61807	15	38			14		55	
61808	16		22				60	
61809	17		24				65	20
61810	18		26	23			75	
61811	19					6		
61812	20		28	24	15		80	15
61813	21		30				110	
61814	22		32	26	16			
61815	23	40					115	10
61816	24		34	28	18		130	
61817	25	41						
61818	26		36	30	20		165	8
61819	27	42						
61820	28		38	32	22		210	7
61821	29	44						
61822	30		40	38	26			
61823	32	45						

○ I DIN 3124

CARACTERÍSTICAS / FEATURES / CARACTÉRISTIQUES

Cr-V

■ MM

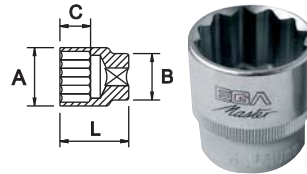

COD.	AF mm	L (mm)	A (mm)	B (mm)	C (mm)	Pt	g	Icon
61380	8		13				48	
61381	9		14		13		49	
61382	10		15				49	
61383	11		17					
61384	12		18	22			50	25
61385	13		19					
61386	14		20					
61387	15	38			14		55	
61388	16		22				60	
61389	17		24				65	20
61390	18		26	23			75	
61391	19					12		
61392	20		28	24	15		80	15
61393	21		30				110	
61394	22		32	26	16			
61395	23	40					115	10
61396	24		34	28	18		130	
61397	25	41						
61398	26		36	30	20		165	8
61399	27	42						
61400	28		38	32	22		210	7
61401	29	44						
61402	30		40	38	26			
61403	32	45						

○ I DIN 3124

CARACTERÍSTICAS / FEATURES / CARACTÉRISTIQUES

Cr-V

1/2"

INCH

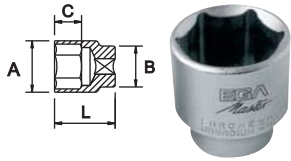

COD.	AF inch	L (mm)	A (mm)	B (mm)	C (mm)	Pt	g	Icon
60460	5/16		13			13	46	
60461	3/8		15				49	
60462	7/16		17				50	
60463	1/2		19					25
60464	9/16		20	22			55	
60465	19/32		22		14			
60466	5/8	38						
60459	21/32		24				65	
60467	11/16						70	20
60468	3/4		26	23			80	
60469	25/32		28	24		6		
60470	13/16			25			85	15
60471	7/8		30		18		95	
60472	15/16		32	26				
60473	31/32	40	33	28			125	10
60474	1		34				135	
60475	1.1/16	42	36					
60476	1.1/8		38	32	19		185	8
60477	1.3/16	44	40		22			
60478	1.1/4		42	34	23		210	7

DIN 3124

CARACTERÍSTICAS / FEATURES / CARACTÉRISTIQUES

Cr-V

INCH

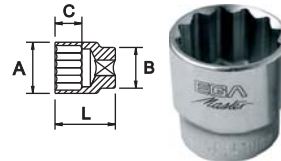

COD.	AF inch	L (mm)	A (mm)	B (mm)	C (mm)	Pt	g	Icon
60480	5/16		13			13	46	
60481	3/8		15				49	
60482	7/16		17				50	
60483	1/2		19					25
60484	9/16		20	22			55	
60485	19/32		22		14			
60486	5/8	38						
60479	21/32		24				65	
60487	11/16						70	20
60488	3/4		26	23			80	
60489	25/32		28	24		12		
60490	13/16			25			85	15
60491	7/8		30		18		95	
60492	15/16		32	26				
60493	31/32	40	33	28			125	10
60494	1		34				135	
60495	1.1/16	42	36					
60496	1.1/8		38	32	19		185	8
60497	1.3/16	44	40		22			
60498	1.1/4		42	34	23		210	7

DIN 3124

CARACTERÍSTICAS / FEATURES / CARACTÉRISTIQUES

Cr-V

x 50% cromado aeroespacial - 50% cromado pulido espejo / 50% aerospace chrome plating - 50% mirror polished chrome plating / 50% chromée aérospatiale - 50% polie chromée

Si no encuentra el artículo que necesita, consúltenos en info@egamaster.com o en www.egamaster.com
If you can't find the item you look for, please ask us in info@egamaster.com or in www.egamaster.com
Si vous ne trouvez pas l'article que vous desirez, consultez-nous a info@egamaster.com ou a www.egamaster.com

1/2"

■ SERIE LARGA / LONG SOCKETS / SÉRIE LONGUE / LANGE SERIE / SERIE LUNGA / SERIE LONGA / ВЫСОКАЯ СЕРИЯ

■ MM

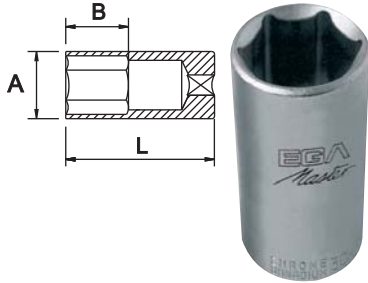

■ INCH

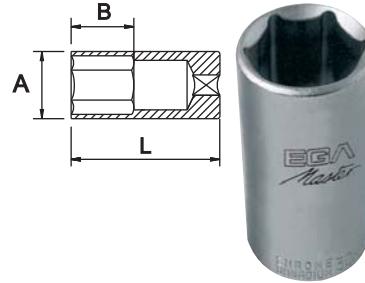

COD.	AF mm	L (mm)	A (mm)	B (mm)	Pt	g	10	•
65044	10		16					
65045	11		17					
65046	12		18					
65047	13		19	22				
65048	14		21					
65049	15		22					
65050	16		22	26				
65051	17		24					
65052	18		26					
65053	x 19	75	26		6		10	•
65054	21		28					
65055	22		30					
65056	23		32					
65057	24		32	32				
67770	26		36					
67771	27		36					
67772	28		38					
67773	29		40					
67774	30		40					
67775	32		42					

○ I DIN 3124

CARACTERÍSTICAS / FEATURES / CARACTÉRISTIQUES

Cr-V

COD.	AF inch	L (mm)	A (mm)	B (mm)	Pt	g	10
65064	3/8		15				
65065	7/16		17	24			
65066	1/2		19	27			
65067	9/16		21				
65068	5/8		22				
65069	y 11/16	75	24		6		10
65070	3/4		26	34			
65071	13/16		27				
65072	7/8		30				
65073	15/16		32				

○ I DIN 3124

CARACTERÍSTICAS / FEATURES / CARACTÉRISTIQUES

Cr-V

1/2"

MM

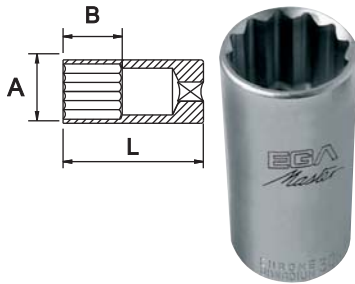

COD.	AP mm	L (mm)	A (mm)	B (mm)	Pt	g		
67780	10		16			110		
67781	11		17					
67782	12		18					
67783	13		19	22		115		
67784	14		21					
67785	15		22			125		
67786	16		26					
67787	17		24			130		
67788	18		26			150		
67789	19		26			165		
67791	x 21	75	28		12	180	10	•
67792	22		30			210		
67793	23		32			240		
67794	24		32	32		260		
67795	26		36			330		
67796	27					350		
67797	28		38			380		
67798	29					420		
67799	30		40			420		
67800	32		42			460		

DIN 3124

CARACTERÍSTICAS / FEATURES / CARACTÉRISTIQUES

Cr-V

INCH

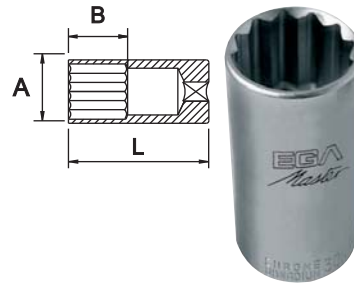

COD.	AP inch	L (mm)	A (mm)	B (mm)	Pt	g		
67805	3/8		15			105		
67806	7/16		17	24		115		
67807	1/2		19	27				
67808	9/16		21			120		
67809	5/8		22					
67810	11/16		24			125		
67811	y 3/4	75	26		12	150	10	•
67812	13/16		27			170		
67813	7/8		30	34		210		
67814	15/16		32			250		
67815	1		34			280		
67816	1.1/16		36			330		
67817	1.1/8		38			370		
67818	1.1/4					455		

DIN 3124

CARACTERÍSTICAS / FEATURES / CARACTÉRISTIQUES

Cr-V

x 50% cromado aeroespacial - 50% cromado pulido espejo / 50% aerospace chrome plating - 50% mirror polished chrome plating / 50% chromée aérospatiale - 50% polie chromée
y 100% cromado pulido espejo / 100% mirror polished chrome plating / 100% polie chromée

1/2"

TORX®*

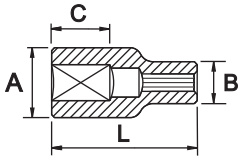

COD.		L (mm)	A (mm)	B (mm)	C (mm)				
57179	E10	38	15	22	10	55	10	●	
57180	E11		17		11	57			
57181	E12		18		62				
57182	E14		20		13	67			
57183	E16		21		73				
57184	E18		24		80				
57185	E20		14		26	23			80
57186	E22				28	25			102
57187	E24								



SPLINE

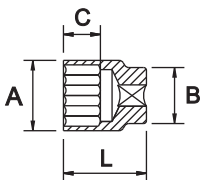

COD.					L (mm)	A (mm)	B (mm)	C (mm)				
55795	-	10	-	-	38	15,5	22	14	47	10	●	
55811	-	-	3/8	-		17			48			
55796	M14	11	7/16	E14		18			25			
55797	M15	12	-	E16		19			50			
55798	M16	13	1/2	-		21			80			
55799	M18	14	-	E18		24			65			
55800	-	15	-	-		17			60			
55801	M20	16	5/8	E20		26			23			75
55802	-	17	-	-		28			24			80
55803	M22	18	-	E22		30			26			70
55804	M24	19	3/4	E24	32	28	17	85				
55805	M25	20	-	-	34	32	19	95				
55806	M26	21	13/16	-	40	34	19	115				
55807	M28	22	7/8	-	42	36	20	140				
55808	M30	24	15/16	-	43	38	32	155				
55833	-	-	1	-	44	40	35	22	180			
55809	M34	27	1.1/16	-								
55834	-	-	1.1/8	-								
55810	M38	30	1.3/16	-								

DIN 3120

CARACTERÍSTICAS / FEATURES / CARACTÉRISTIQUES

Cr-V

*Para tornillos TORX® (Marca registrada por Acument Intellectual Properties, LLC, Troy, Mich., US) / *For screws TORX® (Acument Intellectual Properties, LLC, Troy, Mich., US registered trademark) / *Pour vis TORX® (Marque enregistrée par Acument Intellectual Properties, LLC, Troy, Mich., US)

y 100% cromado pulido espejo / 100% mirror polished chrome plating / 100% polie chromée

1/2"

EXTRACTOR DE TUERCAS DESGASTADAS HASTA EL 50% / SCREW EXTRACTOR FOR 50% ROUNDED OFF NUTS / EXTRACTEUR D'ÉCROUS USÉS JUSQU'À 50% / AUSZIEHER 50%
 ABGENUTZTE MUTTER / ESTRATTORE PER DADI SPANATI FINO AL 50% / EXTRACTOR DE PORCAS DESGASTADAS ATÉ 50% / СЪЁМНИК ДЛЯ СВЕРНУТЫХ НА 50% ГАЕЕК

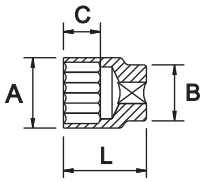

COD.	AF mm	L (mm)	A (mm)	B (mm)	C (mm)	g		
55795	10		15,5			47		
55796	11		17			48		
55797	12		18					
55798	13		19					
55799	14		21		14	50	25	
55800	15							
55801	16	38	24			65		
55802	17					60	20	•
55803	18					75		
55804	19		26	23		60		
55805	20		28	24		80	15	
55806	21				17	70		
55807	22		30	26		85		
55808	24		32	28		95	10	
55809	27	42	36	32	20	140		
55810	30	44	40	35	22	180	8	

DIN 3120

CARACTERÍSTICAS / FEATURES / CARACTÉRISTIQUES

Cr-V

PUNTAS ATORNILLADORAS CON VASO / SOCKET BITS / EMBOUTS DE VISSAGE AVEC DOUILLE / STECKSCHLÜSSELEINSATZ / INSERTI A BUSSOLA / PONTAS APARAFUSADORAS COM CAIXA / ГОЛОВКИ-БИТЫ

PLANA / FLAT / À FENTE / FLACH / PIATTA / PLANA / ПЛОСКАЯ

COD.	mm	L (mm)	g		
66801	1,2 x 8				
66802	1,6 x 10	62	75	10	•
66803	2 x 12				



PHILIPS

COD.		L (mm)	g		
66804	PH-2				
66805	PH-3	56	70	10	•
66806	PH-4				



HEXAGONAL / HEXAGONAL / HEXAGONALE / HEXAGONAL / ESAGONALE / HEXAGONAL / ШЕСТИГРАННАЯ





MM

COD.	mm	L (mm)	g		
66807	4				
66808	5				
55704	5,5				
66809	6	55	75	10	•
66810	7				
66811	8				







y 100% cromado pulido espejo / 100% mirror polished chrome plating / 100% polie chromée

1/2"

COD.		L (mm)			
55705	9,5	55	75	10	●
66812	10		80		
66813	12		95		
55706	13		150		
66814	14				
55708	17				
55707	19				





INCH

COD.		L (mm)			
55688	7/32	55	75	10	●
55689	1/4		80		
55690	5/16		95		
55691	3/8		115		
55692	7/16		120		
55693	1/2				
55695	5/8				
55696	3/4				







HEXAGONAL SERIE LARGA / HEXAGONAL LONG / HEXAGONALE SÉRIE LONGUE / HEXAGONAL LANG / ESAGONALE SERIE LUNGO / HEXAGONAL SÉRIE LONGA / ШЕСТИГРАННАЯ ВЫСОКАЯ

MM

COD.		L (mm)			
66815	5	100	75	10	●
66816	6				
66817	7				
66818	8				
66819	10				
66842	14				







INCH

COD.		L (mm)			
56985	7/32	100	90	10	●
56986	1/4		95		
56987	5/16		100		
56988	3/8		110		
56989	7/16		115		
56990	1/2		170		
56991	9/16		235		
56992	5/8		350		
56993	3/4				







XZN

COD.		L (mm)			
66820	M-5	55	75	10	●
66821	M-6				
66822	M-8				
66823	M-10				
66824	M-12				
66825	M-14				
56896	M-16				







1/2"

XZN SERIE LARGA / XZN LONG / XZN SÉRIE LONGUE / XZN LANG / XZN SERIE LUNGO / XZN SÉRIE LONGA / XZN ДЛИННАЯ

COD.		L (mm)			
66826	M-6	100	100	10	●
66827	M-8		120		
66828	M-10		160		
66829	M-12		165		
56897	M-14				







TORX®*

COD.		L (mm)			
66830	T-20	55	80	10	●
66831	T-25				
66832	T-27				
66833	T-30				
66834	T-40				
66835	T-45				
66836	T-50				
66837	T-55				
56895	T-60				







TORX®* SERIE LARGA / TORX®* LONG / TORX®* SÉRIE LONGUE / TORX®* LANG / TORX®* SERIE LUNGO / TORX®* SÉRIE LONGA / TORX®* ДЛИННАЯ

COD.		L (mm)			
66838	T-40	100	100	10	●
66839	T-45		110		
66840	T-50				
66841	T-55				



PUNTA RIBE®* CON VASO / RIBE®* BIT SOCKETS / POINTE RIBE®* AVEC DOUILLE / RIBE®* SOCKETBIT / CHIAVI A BUSSOLA PUNTA RIBE®* / PONTEIRA RIBE®* COM CHAVE DE CAIXA / ГОЛОВКА ТОРЦЕВАЯ СО ВСТАВКОЙ С ПРОФИЛЕМ RIBE®*

COD.		L (mm)			
65985	M5	100	90	10	●
65986	M6				
65987	M7		95		
65988	M8		100		
65989	M9		110		
65990	M10		150		
65991	M12		180		
65992	M14		200		
65993	M16				



* Para tornillos TORX® (Marca registrada por Acument Intellectual Properties, LLC, Troy, Mich., US) / *For screws TORX® (Acument Intellectual Properties, LLC, Troy, Mich., US registered trademark) / *Pour vis TORX® (Marque enregistrée par Acument Intellectual Properties, LLC, Troy, Mich., US)
 * Para tornillos RIBE® (Marca registrada por Richard Bergner Verbindungstechnik GmbH & Co. KG) / *For screws RIBE® (Richard Bergner Verbindungstechnik GmbH & Co. KG registered trademark) / *Pour vis RIBE® (Marque enregistrée par Richard Bergner Verbindungstechnik GmbH & Co. KG)

1/2"

■ SET

COD.	AF inch	PCS.	g	PCS.	Composición / Composition / Composition
55993	1/2	900	1	66801, 66802, 66803, 66804, 66805, 66806, 66807, 66808, 66809, 66811, 66812, 66813	1,2 x 8 - 6 x 10 - 2 x 12 mm - PH-2, PH-3, PH-4 - HEX-4 - HEX-5 - HEX-6 - HEX-8 - HEX-10 - HEX-12
55994		1200		66807, 66808, 55704, 66809, 66810, 66811, 55705, 66812, 66813, 55706, 66814, 55707	HEX-4 - HEX-5 - HEX-5,5 - HEX-6 - HEX-7 - HEX-8 - HEX-9,5 - HEX-10 - HEX-12 - HEX-13 - HEX-14 - HEX-19
55998		750		55688, 55689, 55690, 55691, 55692, 55693, 55695, 55696	HEX-7/32" - HEX-1/4" - HEX-5/16" - HEX-3/8" - HEX 7/16" - HEX-1/2" - HEX-5/8" - HEX-3/4" - HEX-14 mm
55995		650		66830, 66831, 66832, 66833, 66834, 66835, 66836, 66837	T-20 - T-25 - T-27 - T-30 - T-40 - T-45 - T-50 - T-55



■ ADAPTADOR / ADAPTER / ADAPTATEUR / VERBINDUNGSTEIL / ADATTATORE / REDUTOR / АДАПТЕР

COD.	AF inch	AF inch	g	PCS.	PCS.
65885	1/2-3/8		50	6	●
65882	1/2-3/4		125		



1/2"

LLAVE FIJA CROW FOOT / OPEN END CROW FOOT WRENCH / CLÉ À FOURCHE CROW FOOT / EINSTECK-MAULSCHLÜSSEL / CHIAVE FISSA CROW FOOT / PONTEIRA DE BOCA COM QUADRADO INTERIOR / РОЖКОВЫЙ КЛЮЧ С КВАДРАТОМ

MM

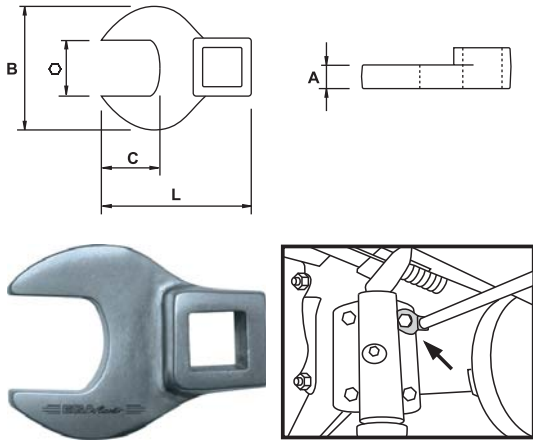

INCH

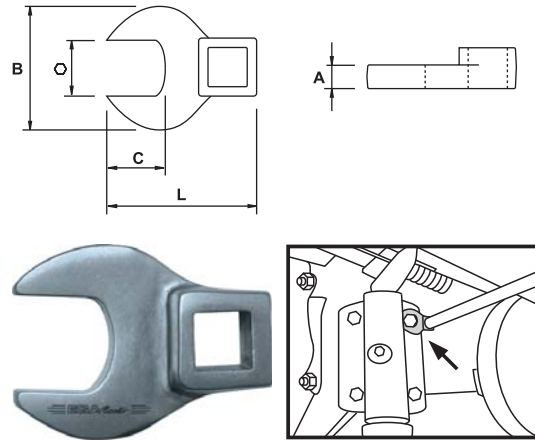

COD.	AF mm	L (mm)	A (mm)	B (mm)	C (mm)	g	Box	Phone
57224	20			42	19			
57225	21	50				150		
57226	22			43	20			
57227	23	55		45	21			
57228	24			46	22	160		
57229	25		12	47	23			
57230	26	60		49	24	185		
57231	27			50	25	190		
57232	28	65		55	26	200		
57233	29			55	27			
57234	30			50	28	210		
57235	31	70		60	29	220		
57236	32			60	30	230		
57237	33			65	31	250	10	•
57238	34			65	32	260		
57239	35	75		70	33	270		
57240	36			70	34	270		
57241	37			70	35	270		
57242	38	80		75	36	280		
57243	39		14	75	37	290		
57244	40			75	38	300		
57245	41	85		80	39	320		
57246	42			80	40	320		
57247	43			80	41	330		
57248	44	90		85	42	340		
57249	45			85	43	360		
57250	46	95	15	90	44	380		

COD.	AF inch	L (mm)	A (mm)	B (mm)	C (mm)	g	Box	Phone
57251	15/16	55		45	21	160		
57252	1	60		47	23	160		
57253	1.1/16		12	50	25	190		
57254	1.1/8	65		50	26	200		
57255	1.3/16			60	28	210		
57256	1.1/4	70		60	30	230		
57257	1.5/16			65	31	250		
57258	1.3/8	75		70	33	260		
57259	1.7/16			70	34	270		
57260	1.1/2	80	14	75	36	280		
57261	1.9/16			75	37	290		
57262	1.5/8	85		80	39	320		
57263	1.11/16			80	41	330		
57264	1.3/4	90		84	42	340	10	•
57265	1.13/16			84	44	380		
57266	1.7/8	95		90	45	400		
57267	1.15/16			90	46	430		
57268	2			95	49	460		
57269	2.1/16	100		95	49	480		
57270	2.1/8			100	50	500		
57271	2.3/16		15	100	50	600		
57272	2.1/4	105		105	55	700		
57273	2.5/16			105	55	700		
57274	2.3/8	110		110	60	750		
57275	2.7/16			110	60	750		
57276	2.1/2			110	60	850		

LLAVES DE VASO PARA BUJÍAS / SPARK PLUG SOCKETS / DOUILLES POUR BOUGIES / ZÜNDKERZEN - STECKSCHLÜSSEL / CHIAVI PER CANDELE / CHAVES DE CAIXA PA VELAS / ГОЛОВКИ ДЛЯ СВЕЧЕЙ ЗАЖИГАНИЯ

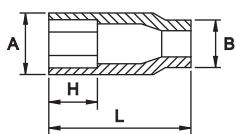

COD.	AF inch	AF mm	L (mm)	A (mm)	B (mm)	H (mm)	g	Box	Phone
61462	1/2	16	65	22	22	14	100	6	•
61463		21		28	24	16	150		



1/2"

MANGO ARTICULADO / SWIVEL HANDLE / MANCHE ARTICULÉ / GELENKGRIF / IMPUGNATURA SNODABILE / CABO ARTICULADO / РУЧКА С ШАРНИРОМ

COD.	AF inch	L (mm)	∠	g
61441	1/2	390	0 - 180°	650



MANGO ARTICULADO DE ACCIÓN RÁPIDA / QUICK RELEASE SWIVEL HANDLE / MANCHE ARTICULÉ ACTION RAPIDE / GELENKGRIF MIT SCHNELLVERSTELLUNG / MANICO SNODABILE AZIONE RAPIDA / CABO ARTICULADO DE AÇÃO RÁPIDA / БЫСТРОСЪЕМНАЯ РУЧКА С ШАРНИРОМ

COD.	AF inch	L (mm)	g	📦
61483	1/2	470	900	5



MANGO ARTICULADO TELESCÓPICO / TELESCOPIC SWIVEL HANDLE / MANCHE ARTICULÉ TÉLESCOPIQUE / TELESKOPISCHE GELENKGRIF / MANICO SNODABILE FLESSIBILE / CABO ARTICULADO TELESCÓPICO / ТЕЛЕСКОПИЧЕСКАЯ РУЧКА С ШАРНИРОМ

COD.	AF inch	L min. (mm)	L max. (mm)	g	📦
61484	1/2	430	650	1150	5



ALARGADERA / EXTENSION / RALLONGE / VERLÄNGERUNG / PROLUNGA / EXTENÇÃO / УДЛИНИТЕЛЬ

COD.	AF inch	L (inch)	g	📦	📋
61453	1/2	3	135	5	•
61455		5	220		-
61458		10	370		-



DIN 3123

BERBIQUÍ / SPEEDER HANDLE / VILLEBREQUIN / KURBEL / LEVA GIROBECCHINO / MANIVELA / КОЛЕНЧАТАЯ РУЧКА

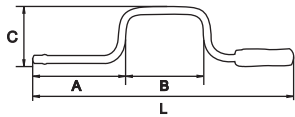

COD.	AF inch	L (mm)	A (mm)	B (mm)	C (mm)	g	📦
61434	1/2	410	130	145	95	550	5



DIN 3122

LLAVE DE CARRACA REVERSIBLE / REVERSIBLE RATCHET HANDLE / CLÉ À CLIQUET RÉVERSIBLE / UMSCHALTKNARRE / CHIAVE A CRICCO REVERSIBILE / ROQUETE REVERSIVEL / РЕВЕРСИВНАЯ ТРЕЩЕТКА

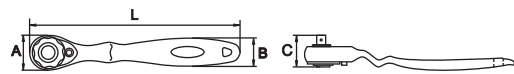

COD.	AF inch	L (mm)	A (mm)	B (mm)	C (mm)	g	📦	📋
61430	1/2	230	39	31	45	550	6	•

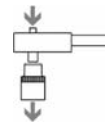

DIN 3122

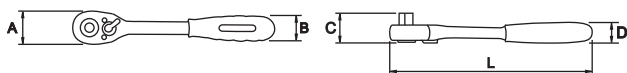

COD.	AF inch	L (mm)	A (mm)	B (mm)	C (mm)	D (mm)	g	📦	📋
61431	1/2	250	37	32	37	28	550	6	•

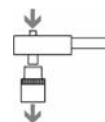

DIN 3122

1/2"

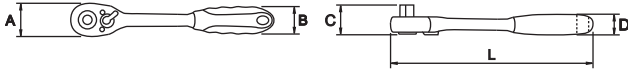

COD.	AF inch	L (mm)	A (mm)	B (mm)	C (mm)	D (mm)	g	Icon	Icon
62606	1/2	250	42	36	37	28	560	6	●

DIN 3122

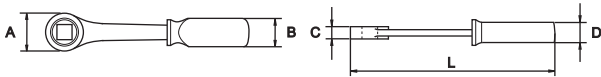
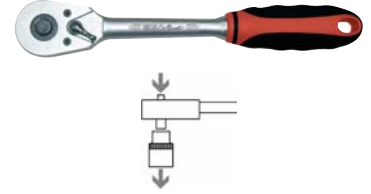

COD.	AF inch	L (mm)	A (mm)	B (mm)	C (mm)	D (mm)	g	Icon	Icon
61168	1/2	280	45	40	25	25	540	6	●

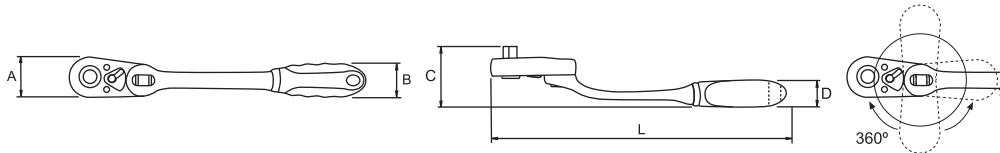

COD.	AF inch	L (mm)	A (mm)	B (mm)	C (mm)	D (mm)	g	Icon	Icon
57410	1/2	310	40	36	72	28	750	6	●

DIN 3122

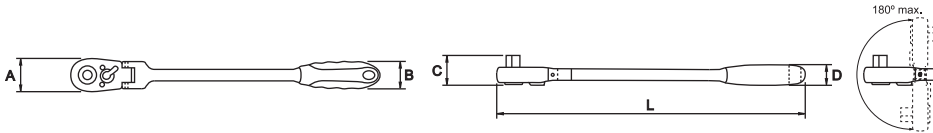

COD.	AF inch	L (mm)	A (mm)	B (mm)	C (mm)	D (mm)	g	Icon	Icon
57413	1/2	450	37	36	38	28	880	6	●

DIN 3122

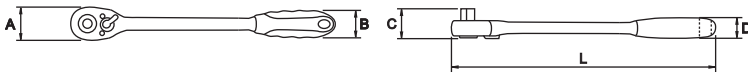

COD.	AF inch	L (mm)	A (mm)	B (mm)	C (mm)	D (mm)	g	Icon	Icon
57416	1/2	380	42	36	38	28	710	6	●

DIN 3122



MANGO CORREDIZO EN "T" / SLIDING "T" HANDLE / POIGNEE COULISSANTE / QUERGRIF / ASTA CON QUADRO SCORREVOLO / CABO "T" CORREDIÇO / ПОДВИЖНАЯ "Т" РУЧКА

COD.	AF inch	L (mm)	g	Icon	Icon
61440	1/2	250	160	5	●

DIN 3122



ARTICULACIÓN UNIVERSAL / UNIVERSAL JOINT / KARDANGELN / SNODO CARDANICO / CARDAN UNIVERSAL / ШАРНИР

COD.	AF inch	g	Icon	Icon
61437	1/2	140	10	●

DIN 3123



■ 3/4"

■ STANDARD

■ MM

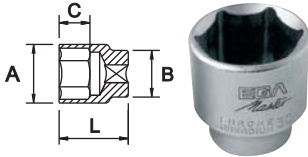

COD.	AF mm	L (mm)	A (mm)	B (mm)	C (mm)	Pt	g	Icon
60501	19		30	33				
60502	21				14	210		
60503	22		32					
60504	23		33		15			
60505	24		34	36				
60506	25	50	36		17	220		
60507	26							
60508	27		38					
60509	28		39		24	230	10	
60510	29		40			250		
60511	30		42			290		
60512	32		44	38	26	300		
60513	33				28			
60514	x 34	55	46		26	6 330		
60515	35		48		28	390		
60516	36		50	42	29	420		
60517	38					470		
60518	40	60		43	31	500		
60519	41		55					
60520	42	65		45	34	550		
60521	46		60		37	650		
60522	50	70	70		38	850	5	
60525	54		75	48	40	1000		
60523	55	75			41			
60524	60	80	80			1100		
60546	65	82	82		45	1350		

⊗ DIN 3124

CARACTERÍSTICAS / FEATURES / CARACTÉRISTIQUES

Cr-V

■ INCH

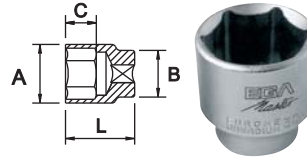

COD.	AF inch	L (mm)	A (mm)	B (mm)	C (mm)	Pt	g	Icon
67595	7/8		33			210		
67596	15/16				17			
67597	1	50	35	36		220		
67598	1.1/16		38		24			
67599	1.1/8		40	38	27	270		
67601	1.1/4		44		28	290	10	
67602	y 1.5/16	55	46	39	29	310		
67603			48			350	6	
67604				42	30	400		
67605	1.7/16	60	50			460		
67607	1.1/2		55	45	32			
67608	1.5/8					550		
67610	1.11/16	65	60		34			
67612	1.13/16			47	35	700	5	
	2	70	70	48	41	850		

⊗ DIN 3124

CARACTERÍSTICAS / FEATURES / CARACTÉRISTIQUES

Cr-V

x 50% cromado aeroespacial - 50% cromado pulido espejo / 50% aerospace chrome plating - 50% mirror polished chrome plating / 50% chromée aérospatiale - 50% polie chromée
y 100% cromado pulido espejo / 100% mirror polished chrome plating / 100% polie chromée

10

LLAVES DE VASO
SOCKET WRENCHES
DOUILLES
STECKSCHLÜSSEL
BUSSOLE
CHAVES DE CAIXA
ГОЛОВКИ



3/4"

MM

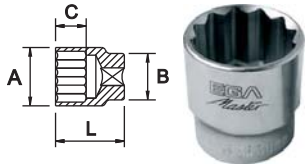

COD.	AF mm	L (mm)	A (mm)	B (mm)	C (mm)	Pt	g	Icon
67565	19		30	33				
67566	21		32		14	210		
67567	22							
67568	23		33		15			
67569	24	50	34	36		220		
67570	25		36		17			
67571	26							
67572	27		38					
67573	29		40		24	250	10	
67574	30		42			290		
67575	32		44	38	26	300		
67576	33				28			
67577	x 34	55	46		26	12 330		
67578	35		48		28	390		
67579	36			42	29	420		
67580	38		50			470		
67581	40	60		43	31	500		
67582	41		55					
67583	42	65		45	34	550		
67584	44					600		
67585	46		60		37	650	5	
67586	50	70	70	48	38	850		
67587	54	75	75		40	1000		
67588	55	41						

DIN 3124

CARACTERÍSTICAS / FEATURES / CARACTÉRISTIQUES

Cr-V

INCH

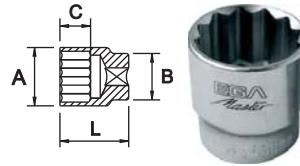

COD.	AF inch	L (mm)	A (mm)	B (mm)	C (mm)	Pt	g	Icon
60526	3/4		30					
60527	7/8		33			210		
60528	15/16	50	35	36	17			
60529	1					220		
60530	1.1/16		38		24			
60531	1.1/8		40		27			
60500	1.3/16		42	38	25	270	10	
60532	1.1/4	55	44		28	290		
60533	y 1.5/16		46	39	29	12 310		
60534	1.3/8		48	42		350		
60535	1.7/16	60	50		30	400		
60536	1.1/2					460		
60537	1.5/8		55	45	32	550		
60538	1.11/16	65			34			
60499	1.3/4		60					
60539	1.13/16			47	35	700	5	
60540	1.7/8	70	65	48	39	850		
60541	2		70		41			

DIN 3124

CARACTERÍSTICAS / FEATURES / CARACTÉRISTIQUES

Cr-V

x 50% cromado aeroespacial - 50% cromado pulido espejo / 50% aerospace chrome plating - 50% mirror polished chrome plating / 50% chromée aérospatiale - 50% polie chromée
y 100% cromado pulido espejo / 100% mirror polished chrome plating / 100% polie chromée

3/4"

SERIE LARGA / LONG SOCKETS / SÉRIE LONGUE / LANGE SERIE / SERIE LUNGA / SERIE LONGA / ВЫСОКАЯ СЕРИЯ

■ MM

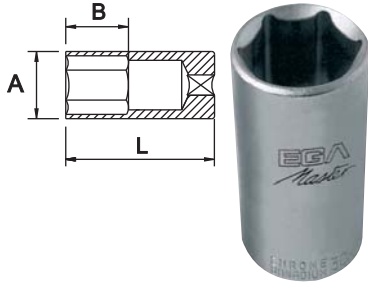

■ INCH

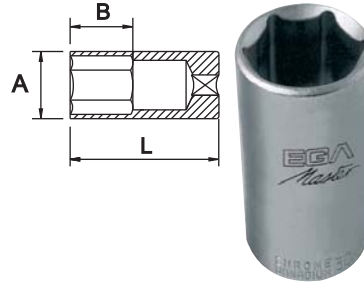

COD.	AF mm	L (mm)	A (mm)	B (mm)	Pt	g	Icon	Icon
56900	19		29			300		
56901	21		31			320		
56902	22		32	26		360		
56903	23		33			380		
56904	24		34			400	10	
56905	26		37					
56906	27					420		
56899	x 28	90	38		6			•
56907	29		40	28		460		
56908	30		42			510		
56909	32		44			560		
56910	34		47			610	5	
56911	36		50	30		670		
56912	38		52	34		700		
56913	41		56			790		

COD.	AF inch	L (mm)	A (mm)	B (mm)	Pt	g	Icon	Icon
56914	3/4		29			300		
56915	7/8		32			360		
56916	15/16		34	26		400		
56917	1		37			410	10	
56918	y 1.1/16	90	38		6	420		
56919	1.1/8		40	28		460		
56920	1.1/4		44			560		
56921	1.3/8		48	30		640	5	
56922	1.1/2		52	34		700		
56923	1.5/8		56			790		

○ I DIN 3124

CARACTERÍSTICAS / FEATURES / CARACTÉRISTIQUES

Cr-V

○ I DIN 3124

CARACTERÍSTICAS / FEATURES / CARACTÉRISTIQUES

Cr-V

ADAPTADOR / ADAPTER / ADAPTATEUR / VERBINDUNGSTEIL / ADATTATORE / REDUTOR / АДАПТЕР

COD.	AF inch	AF inch	g	Icon	Icon
65883	3/4-1		250		
65886	3/4-1/2"		135	6	•



LLAVE DE CARRACA REVERSIBLE / REVERSIBLE RATCHET HANDLE / CLÉ À CLIQUET RÉVERSIBLE / UMSCHALTKNARRE / CHIAVE A CRICCO REVERSIBILE / ROQUETE REVERSIVEL / РЕВЕРСИВНАЯ ТРЕЩЕТКА



COD.	AF inch	L (mm)	A (mm)	B (mm)	C (mm)	Kg
61863	3/4	500	67	26	57	2,3

DIN 3122



MANGO ARTICULADO / SWIVEL HANDLE / MANCHE ARTICULÉ / GELENKGRIF / IMPUGNATURA SNODABILE / CABO ARTICULADO / РУЧКА С ШАРНИРОМ

COD.	AF inch	L (mm)	Kg	Icon
61473	3/4	1000	3,7	
61456		480	1,9	6



x 50% cromado aeroespacial - 50% cromado pulido espejo / 50% aerospace chrome plating - 50% mirror polished chrome plating / 50% chromée aérospatiale - 50% polie chromée
y 100% cromado pulido espejo / 100% mirror polished chrome plating / 100% polie chromée

3/4"

■ MANGO CORREDIZO EN "T" / SLIDING "T" HANDLE / POIGNEE COULISSANTE / QUERGRIF / ASTA CON QUADRO SCORREVOLO / CABO "T" CORREDIÇO / ПОДВИЖНАЯ "Т" РУЧКА

COD.	AF inch	L (mm)	g	
61864	3/4	450	1200	5

DIN 3122



■ ARTICULACIÓN UNIVERSAL / UNIVERSAL JOINT / CARDAN UNIVERSEL / KARDANGELNENK / SNODO CARDANICO / CARDAN UNIVERSAL / ШАРНИР

COD.	AF inch	g		
61860	3/4	600	6	•

DIN 3123



■ ALARGADERA / EXTENSION / RALLONGE / VERLÄNGERUNG / PROLUNGA / EXTENÇÃO / УДЛИНИТЕЛЬ

COD.	AF inch	L (inch)	g		
61865	3/4	4	410	5	•
63910		5	480		
61866		8	700		
63911		12	1050		
63912		16	1300		
63913		20	1650		

DIN 3123



EGGA Master
ART IN INNOVATION

■ 1"

■ STANDARD

■ MM

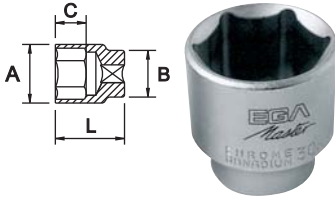

■ INCH

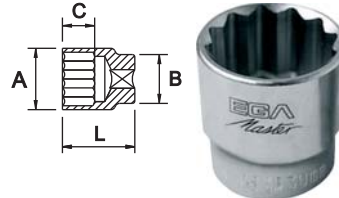

COD.	AF mm	L (mm)	A (mm)	B (mm)	C (mm)	Pt	g	
65001	36	65	50	45	32	500		
65002	41	70	55	45	35	600		
65003	46	75	65	50	39	850		
65004	50	70			41	1050	5	
65005	54					1150		
65006	55	80	75		42	1250		
65007	58					1300		
65008	60		80	55		1400		
65009	x 63	85	85		47	1500	6	
65010	65					1550		
65011	67	90	90		50	1650		
65012	70					2050	4	
65013	71	95	95		55	2050		
65014	75		100	70		2400		
65015	77	105	105		60	2550		
65016	80							

■ DIN 3124

COD.	AF inch	L (mm)	A (mm)	B (mm)	C (mm)	Pt	g	
65022	1.5/8	70	55	45	35	550		
65023	1.13/16		65	50		800		
65024	1.7/8	75			37	950		
65025	2		70			1000	5	
65026	2.1/8					1100		
65027	2.3/16	80	75		38	1150		
65028	x 2.1/4			55	43	1200	12	
65029	2.3/8		80		45	1300		
65030	2.1/2	85	85		48	1400		
65031	2.5/8	90	90		50	1550		
65032	2.3/4	95	95		55	1950	4	
65033	3			70				
65034	3.1/8	105	105	70	60	2450		

■ DIN 3124

CARACTERÍSTICAS / FEATURES / CARACTÉRISTIQUES

Cr-V

CARACTERÍSTICAS / FEATURES / CARACTÉRISTIQUES

Cr-V

■ ADAPTADOR / ADAPTER / ADAPTATEUR / VERBINDUNGSTEIL / ADATTATORE / REDUTOR / АДАПТЕР

COD.	AF inch	AF inch	g		
65040	1-3/4		430	6	●



■ MANGO ARTICULADO / SWIVEL HANDLE / MANCHE ARTICULÉ / GELENKGRIF / IMPUGNATURA SNODABILE / CABO ARTICULADO / РУЧКА С ШАРНИРОМ

COD.	AF inch	L (mm)	Kg	
61474	1	1000	4,0	6



COD.	AF inch	L (mm)	Kg	
61457	1	650	2,5	6



■ LLAVE DE CARRACA REVERSIBLE / REVERSIBLE RATCHET HANDLE / CLÉ À CLIQUET RÉVERSIBLE / UMSCHALTKNARRE / CHIAVE A CRICCO REVERSIBILE / ROQUETE REVERSIVEL / РЕВЕРСИВНАЯ ТРЕЩЕТКА

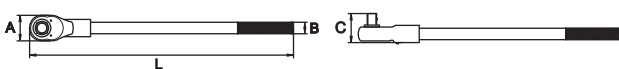

COD.	AF inch	L (mm)	A (mm)	B (mm)	C (mm)	Kg	
65035	1	650	71	29	67	4,4	1



x 50% cromado aeroespacial - 50% cromado pulido espejo / 50% aerospace chrome plating - 50% mirror polished chrome plating / 50% chromée aérospatiale - 50% polie chromée

1"

MANGO CORREDIZO EN "T" / SLIDING "T" HANDLE / POIGNEE COULISSANTE / QUERGRIF / ASTA CON QUADRO SCORREVOLO / CABO "T" CORREDIÇO / ПОДВИЖНАЯ "Т" РУЧКА

COD.	AF inch	L (mm)	g	
65036	1	550	3300	1

DIN 3122

ARTICULACIÓN UNIVERSAL / UNIVERSAL JOINT / CARDAN UNIVERSEL / KARDANGELNENK / SNODO CARDANICO / CARDAN UNIVERSAL / ШАРНИР

COD.	AF inch	g		
65039	1	1200	4	●

DIN 3123







ALARGADERA / EXTENSION / RALLONGE / VERLÄNGERUNG / PROLUNGA / EXTENÇÃO / УДЛИНИТЕЛЬ

COD.	AF inch	L (mm)	L (inch)	g	
65037	1	200	8	1150	5
65038		400	12	2300	

DIN 3123











KITS - SETS
1/4"
18 PCS.

COD.	AF inch	PCS.	Kg
55591	1/4	18	0,6

PCS./UN.	Composición / Composition / Composition	Descripción / Description / Description		
13	61311, 63974, 61312, 63975, 61313, 61314, 61315, 61316, 61317, 61318, 61319, 61320, 61321	Llaves de vaso / Socket wrenches	4-4,5-5-5,5-6-7-8-9-10-11-12-13-14 mm	
	61428	Carraca / Ratchet	-	
	61443	Alargadera / Extension	4"	
	61438	Mango en T / T Handle		
1	61435	Articulación universal / Universal joint	-	
	-	Destornillador portavasos / Socket holder		

29 PCS.

COD.	AF inch	PCS.	Kg
61958	1/4	29	0,8
61961			

PCS./UN.	Composición / Composition / Composition	Descripción / Description / Description		
11	60420, 60421, 60422, 60423, 60424, 60425, 60426, 60427, 60428, 60429, 60430	Llaves de vaso / Socket wrenches	5/32"-3/16"-7/32"-1/4"-9/32"-5/16"-11/32"-3/8"-7/16"-1/2"-9/16"	
1	61428	Carraca / Ratchet	-	
2	61442, 61444	Alargadera / Extension	2"-6"	
	61438	Mango en T / T Handle		
1	61435	Articulación universal / Universal joint	-	
5		Punta hexagonal con vaso / Hex bit socket	3-4-5-6-8	
3		Punta plana con vaso / Flat bit socket	4 x 0,6 - 5,5 x 1 - 7 x 1,2	
4		Punta Philips con vaso / Philips bit socket	PH1-PH2-PH3-PH4	
1		Destornillador portavasos / Socket holder		



10

LLAVES DE VASO
SOCKET WRENCHES
DOUILLES
STECKSCHLÜSSEL
BUSSOLE
CHAVES DE CAIXA
ГОЛОВКИ



1/4"

COD.		PCS.	
55667	1/4	29	0,8

PCS./UN.	Composición / Composition / Composition	Descripción / Description / Description		
11	56015, 56017, 56018, 56019, 56020, 56021, 56023, 56024, 56025, 56026, 56027	Spline	M5, M6, M7, M8, M9, M10, M12, M14, M15, M16, M18	
1	61428	Carraca / Ratchet	-	
2	61442, 61444	Alargadera / Extension	2"-6"	
	61438	Mango en T / T Handle	-	
1	61435	Articulación universal / Universal joint	-	
5	-	Punta hexagonal con vaso / Hex bit socket	3-4-5-6-8	
3	-	Punta plana con vaso / Flat bit socket	4 x 0,6 - 5,5 x 1 - 7 x 12	
4	-	Punta Philips con vaso / Philips bit socket	PH1-PH2-PH3-PH4	
1	-	Destornillador portavasos / Socket holder	-	



30 PCS.

COD.		PCS.	
55592	1/4	30	1,5

PCS./UN.	Composición / Composition / Composition	Descripción / Description / Description		
11	61322, 61311, 61312, 63975, 61313, 61314, 61315, 61316, 61317, 61318, 61319 60420, 60421, 60422, 60423, 60424, 60425, 60426, 60427, 60428, 60429, 60430	Llaves de vaso / Socket wrenches	3,2-4-5-5,5-6-7-8-9-10-11-12 mm 5/32"-3/16"-7/32"-1/4"-9/32"-5/16"-11/32"-3/8"-7/16"-1/2"-9/16"	
1	61428	Carraca / Ratchet	-	
2	61442, 61444	Alargadera / Extension	2"-6"	
	61445	Alargadera flexible / Flexible handle	-	
	65874	Mango articulado / Hinged handle	-	
1	61438	Mango en T / T Handle	-	
	61435	Articulación universal / Universal joint	-	
	-	Destornillador portavasos / Socket holder	-	



33 PCS.

COD.		PCS.	
55590	1/4	33	1,5

PCS./UN.	Composición / Composition / Composition	Descripción / Description / Description		
13	61322, 61311, 61312, 63975, 61313, 61314, 61315, 61316, 61317, 61318, 61319, 61320, 61321	Llaves de vaso / Socket wrenches	3,2-4-5-5,5-6-7-8-9-10-11-12-13-14 mm	
12	67640, 67642, 67643, 67644, 67645, 67646, 67647, 67648, 67649, 67650, 67651	Llaves de vaso serie larga / Long socket wrenches	4-5-5,5-6-7-8-9-10-11-12-13-14 mm	
1	61428	Carraca / Ratchet	-	
2	61442, 61444	Alargadera / Extension	2"-6"	
1	61445	Alargadera flexible / Flexible handle	-	



10

LLAVES DE VASO
SOCKET WRENCHES
DOUILLES
STECKSCHLÜSSEL
BUSSOLE
CHAVES DE CAIXA
ГОЛОВКИ



1/4"

PCS./UN.	Composición / Composition / Composition	Descripción / Description / Description		
1	65874	Mango articulado / Hinged handle		
	61438	Mango en T / T Handle		
	61435	Articulación universal / Universal joint	-	
	-	Destornillador portavasos / Socket holder		

24 PCS.

COD.		PCS.	
61791	1/4	24	0,8

PCS./UN.	Composición / Composition / Composition	Descripción / Description / Description		
10	61311, 61312, 61313, 61314, 61315, 61316, 61317, 61318, 61319, 61320	Llaves de vaso / Socket wrenches	4-5-6-7-8-9-10-11-12-13 mm	
9	60421, 60422, 60423, 60424, 60425, 60426, 60427, 60428, 60429		3/16"-7/32"-1/4"-9/32"-5/16"-11/32"-3/8"-7/16"-1/2"	
1	61595	Carraca / Ratchet	-	
	61442	Alargadera / Extension	2"	
	61435	Articulación universal / Universal joint		
	65874	Mango articulado / Hinged handle	-	
-		Destornillador portavasos / Socket holder		



12 PCS.

COD.		PCS.		COD.	PCS.		
61323	1/4	12	0,4	61311, 61312, 61313, 61314, 61315, 61316, 61317, 61318, 61319, 61320, 61321	4-5-6-7-8-9-10-11-12-13-14	-	
61324				60420, 60421, 60422, 60423, 60424, 60425, 60426, 60427, 60428, 60429, 60430	-	5/32 - 3/16 - 7/32 - 1/4 - 9/32 - 5/16 - 11/32 - 3/8 - 7/16 - 1/2 - 9/16	



3/8"

12 PCS.



COD.		PCS.	
55595	3/8	12	1,2





PCS./UN.	Composición / Composition / Composition	Descripción / Description / Description		
10	67541, 67542, 67543, 67545, 67546, 67547, 67548, 67549, 67552, 67554	Llaves de vaso / Socket wrenches	6-7-8-10-11-12-13-14-17-19 mm	
1	61429	Carraca / Ratchet	-	
	61447	Alargadera / Extension	6"	



3/8"



16 PCS.





COD.		PCS.	
61959	3/8	16	1,7
61962			

PCS./UN.	Composición / Composition / Composition	Descripción / Description / Description					
11	60440, 60442, 60443, 60444, 60445, 60446, 60447, 60448, 60449, 60450, 60451	Llaves de vaso / Socket wrenches 5/16"-3/8"-7/16"-1/2"-9/16"-19/32" - 5/8"-11/16"-3/4"-13/16"-7/8"					
1	61429	Carraca / Ratchet					
2	61447, 61450	Alargadera / Extension					
	61439	Mango en T / T Handle					
1	61436	Articulación universal / Universal joint					





19 PCS.





COD.		PCS.	
55596	3/8	19	1,8

PCS./UN.	Composición / Composition / Composition	Descripción / Description / Description					
15	60439, 60440, 60441, 60442, 60443, 60444, 60445, 60446, 60447, 60448, 60449, 60450, 60451, 60452	Llaves de vaso / Socket wrenches 1/4", 5/16", 11/32", 3/8", 7/16", 1/2", 9/16", 19/32", 5/8", 11/16", 3/4", 13/16", 7/8", 15/16"					
1	61429	Carraca / Ratchet					
2	61447, 61450	Alargadera / Extension					
	61439	Mango en T / T Handle					
1	61436	Articulación universal / Universal joint					





21 PCS.





COD.		PCS.	
55593	3/8	21	1,5

PCS./UN.	Composición / Composition / Composition	Descripción / Description / Description					
19	67539, 67540, 61343, 61344, 61345, 61346, 61347, 61348, 61349, 61350, 61351, 61352, 61353, 61354, 61355, 61356, 61357, 67560, 67561	Llaves de vaso / Socket wrenches 6-7-8-9-10-11-12-13-14-15-16-17-18-19-20-21-22-23-24 mm					
1	61429	Carraca / Ratchet					
	61447	Alargadera / Extension					



26 PCS.

COD.		PCS.	
55594	3/8	26	2,75

PCS./UN.	Composición / Composition / Composition	Descripción / Description / Description					
19	67541, 67542, 67543, 67544, 67545, 67546, 67547, 67548, 67549, 67550, 67551, 67552, 67553, 67554, 67555, 67556, 67557, 67558, 67559	Llaves de vaso / Socket wrenches 6-7-8-9-10-11-12-13-14-15-16-17-18-19-20-21-22-23-24 mm					
1	61429	Carraca / Ratchet					
2	61447, 61450	Alargadera / Extension					
1	61439	Mango en T / T Handle					



10

LLAVES DE VASO SOCKET WRENCHES DOUILLES STECKSCHLÜSSEL BUSSOLE CHAVES DE CAIXA ГОЛОВКИ



3/8"

PCS./UN.	Composición / Composition / Composition	Descripción / Description / Description	
1	61436	Articulación universal / Universal joint	
2	61460, 61461	Llaves de vaso para bujías / Spark plug socket	

42 PCS.

COD.		PCS.	
61792	3/8	42	5,0

PCS./UN.	Composición / Composition / Composition	Descripción / Description / Description	
11	61344, 61345, 61346, 61347, 61348, 61349, 61350, 61351, 61352, 61353, 61354	Llaves de vaso / Socket wrenches	9-10-11-12-13-14-15-16-17-18-19 mm
7	60442, 60443, 60444, 60445, 60447, 60448, 60449		3/8"-7/16"-1/2"-9/16"-5/8"-11/16"-3/4"
11	67727, 67728, 67729, 67730, 67731, 67732, 67733, 67734, 67735, 67736, 67737	Llaves de vaso serie larga / Long socket wrenches	9-10-11-12-13-14-15-16-17-18-19 mm
7	67752, 67753, 67754, 67755, 67757, 67758, 67759		3/8"-7/16"-1/2"-9/16"-5/8"-11/16"-3/4"
1	61596	Carraca / Ratchet	
3	61459, 61447, 61449	Alargadera / Extension	3"-6"-8"
1	61436	Articulación universal / Universal joint	
	65875	Mango articulado / Hinged handle	



16 PCS.

COD.		PCS.		COD. PCS.		
61341	3/8	16	1,0	61343, 61344, 61345, 61346, 61347, 61348, 61349, 61350, 61351, 61352, 61353, 61354, 61355, 61356, 61357	8-9-10-11-12-13-14-15-16-17-18-19-20-21-22	61429









13 PCS.

COD.		PCS.		COD. PCS.		
61342	3/8	13	0,9	60440, 60441, 60442, 60443, 60444, 60445, 60446, 60447, 60448, 60449, 60450, 60451	5/16 - 11/32 - 3/8 - 7/16 - 1/2 - 9/16 - 19/32 - 5/8 - 11/16 - 3/4 - 13/16 - 7/8	61429







■ 1/2"

■ 19 PCS.







COD.		PCS.	
55668	1/2	19	3,5
PCS./UN.	Composición / Composition / Composition	Descripción / Description / Description	
14	55795, 55796, 55797, 55798, 55799, 55801, 55803, 55804, 55805, 55806, 55807, 55808, 55809, 55810	Spline	M12, M14, M15, M16, M18, M20, M22, M24, M25, M26, M28, M30, M34, M38 
1	61431	Carraca / Ratchet	- 
2	61455, 61458	Alargadera / Extension	5"-10" 
	61440	Mango en T / T Handle	
1	61437	Articulación universal / Universal joint	- 



■ 20 PCS.

COD.		PCS.	
55599	1/2	20	2,95
PCS./UN.	Composición / Composition / Composition	Descripción / Description / Description	
16	61800, 61801, 61802, 61803, 61804, 61805, 61806, 61807, 61808, 61809, 61810, 61811, 61813, 61814, 61815, 61816	Llaves de vaso / Socket wrenches	8-9-10-11-12-13-14-15-16-17-18-19-21-22-23-24 mm 
1	61431	Carraca / Ratchet	- 
2	61455, 61458	Alargadera / Extension	5"-10" 
1	61437	Articulación universal / Universal joint	- 



COD.		PCS.	
55600	1/2	20	2,95
PCS./UN.	Composición / Composition / Composition	Descripción / Description / Description	
16	61382, 61383, 61384, 61385, 61386, 61387, 61388, 61389, 61390, 61391, 61393, 61394, 61395, 61396	Llaves de vaso / Socket wrenches	8-9-10-11-12-13-14-15-16-17-18-19-21-22-23-24 mm 
1	61431	Carraca / Ratchet	- 
2	61455, 61458	Alargadera / Extension	5"-10" 
1	61437	Articulación universal / Universal joint	- 



10

LLAVES DE VASO
SOCKET WRENCHES
DOUILLES
STECKSCHLÜSSEL
BUSSOLE
CHAVES DE CAIXA
ГОЛОВКИ



1/2"

21 PCS.

COD.		PCS.	
55601	1/2	21	3,5

PCS./UN.	Composición / Composition / Composition	Descripción / Description / Description					
16	61802, 61803, 61804, 61805, 61806, 61807, 61808, 61809, 61810, 61811, 61813, 61814, 61816, 61819, 61822, 61823	Llaves de vaso / Socket wrenches	10-11-12-13-14-15-16-17-18-19-21-22-24-27-30-32 mm				
1	61431	Carraca / Ratchet	-				
2	61455, 61458	Alargadera / Extension	5"-10"				
	61440	Mango en T / T Handle					
1	61437	Articulación universal / Universal joint					



25 PCS.

COD.		PCS.	
61960	1/2	25	4,2
61963	1/2	25	4,2

PCS./UN.	Composición / Composition / Composition	Descripción / Description / Description					
20	60480, 60481, 60482, 60483, 60484, 60485, 60486, 60479, 60487, 60488, 60489, 60490, 60491, 60492, 60493, 60494, 60495, 60496, 60497, 60498	Llaves de vaso / Socket wrenches	5/16"-3/8"-7/16"-1/2"-9/16"-19/32"-5/8"-21/32"-11/16"-3/4"-25/32"-13/16"-7/8"-15/16"-31/32"-1"-1.1/16"-1.1/8"-1.3/16"-1.1/4"				
1	61431	Carraca / Ratchet	-				
2	61455, 61458	Alargadera / Extension	5"-10"				
	61440	Mango en T / T Handle					
1	61437	Articulación universal / Universal joint					



COD.		PCS.	
55602	1/2	25	3,5

PCS./UN.	Composición / Composition / Composition	Descripción / Description / Description					
21	61380, 61381, 61382, 61383, 61384, 61385, 61386, 61387, 61388, 61389, 61390, 61391, 61393, 61394, 61395, 61396, 61398, 61399, 61400, 61402, 61403	Llaves de vaso / Socket wrenches	10-11-12-13-14-15-16-17-18-19-20-21-22-23-24-25-26-27-28-30-32 mm				
	61431	Carraca / Ratchet	-				
	61455	Alargadera / Extension	5"				
1	61440	Mango en T / T Handle					
	61437	Articulación universal / Universal joint					



10

LLAVES DE VASO
SOCKET WRENCHES
DOUILLES
STECKSCHLÜSSEL
BUSSOLE
CHAVES DE CAIXA
ГОЛОВКИ



1/2"

28 PCS.

COD.		PCS.	
55597	1/2	28	5,35

PCS./UN.	Composición / Composition / Composition	Descripción / Description / Description		
22	61800, 61801, 61802, 61803, 61804, 61805, 61806, 61807, 61808, 61809, 61810, 61811, 61813, 61814, 61815, 61816, 61818, 61819, 61820, 61821, 61822, 61823	Llaves de vaso / Socket wrenches	8-9-10-11-12-13-14-15-16-17-18-19-21-22-23-24-26-27-28-29-30-32 mm	
1	61431	Carraca / Ratchet	-	
2	61455, 61458	Alargadera / Extension	5"-10"	
	61440	Mango en T / T Handle		
1	61437	Articulación universal / Universal joint	-	
	61434	Berbiqui / Speeder handle		



COD.		PCS.	
55598	1/2	28	5,35

PCS./UN.	Composición / Composition / Composition	Descripción / Description / Description		
22	61380, 61381, 61382, 61383, 61384, 61385, 61386, 61387, 61388, 61389, 61390, 61391, 61393, 61394, 61395, 61396, 61398, 61399, 61400, 61401, 61402, 61403	Llaves de vaso / Socket wrenches	8-9-10-11-12-13-14-15-16-17-18-19-21-22-23-24-26-27-28-29-30-32 mm	
1	61431	Carraca / Ratchet	-	
2	61455, 61458	Alargadera / Extension	5"-10"	
	61440	Mango en T / T Handle		
1	61437	Articulación universal / Universal joint	-	
	61434	Berbiqui / Speeder handle		



35 PCS.

COD.		PCS.	
55603	1/2	35	5,7

PCS./UN.	Composición / Composition / Composition	Descripción / Description / Description		
11	61802, 61803, 61805, 61806, 61809, 61811, 61814, 61816, 61819, 61822, 61823		10-11-13-14-17-19-22-24-27-30-32 mm	
19	60460, 60461, 60459, 60462, 60463, 60464, 60465, 60466, 60467, 60468, 60469, 60470, 60471, 60472, 60474, 60475, 60476, 60477, 60478	Llaves de vaso / Socket wrenches	5/16"-3/8"-7/16"-1/2"-9/16"-19/32"-5/8"-21/32"-11/16"-3/4"-25/32"-13/16"-7/8"-15/16"-1"-1.1/16"-1.1/8"-1.3/16"-1.1/4"	
1	61431	Carraca / Ratchet	-	
2	61455, 61458	Alargadera / Extension	5"-10"	
1	61437	Articulación universal / Universal joint	-	
	61434	Berbiqui / Speeder handle		



10

**LLAVES DE VASO
SOCKET WRENCHES
DOUILLES
STECKSCHLÜSSEL
BUSSOLE
CHAVES DE CAIXA
ГОЛОВКИ**



1/2"

17 PCS.

COD.	AF inch	PCS.	Kg	COD. PCS.	AF mm	AF inch	
61796	1/2	17	2,0	61802, 61803, 61804, 61805, 61806, 61807, 61808, 61809, 61810, 61811, 61812, 61814, 61816, 61819, 61822, 61823	10-11-12-13-14-15-16-17-18- 19-20-22-24-27-30-32	-	61431
61798				60460, 60461, 60462, 60463, 60464, 60466, 60467, 60468, 60470, 60471, 60472, 60474, 60475, 60476, 60477, 60478	-	5/16 - 3/8 - 7/16 - 1/2 - 9/16 - 5/8 - 11/16 - 3/4 - 13/16 - 7/8 - 15/16 - 1 - 1.1/16 - 1.1/8 - 1.3/16 - 1.1/4	



COD.	AF inch	PCS.	Kg	COD. PCS.	AF mm
61797	1/2	17	2,0	61382, 61383, 61384, 61385, 61386, 61387, 61388, 61389, 61390, 61391, 61392, 61394, 61396, 61399, 61402, 61403	10-11-12-13-14-15-16- 17-18-19-20-22-24-27- 30-32
61799				60480, 60481, 60482, 60483, 60484, 60486, 60487, 60488, 60490, 60491, 60492, 60494, 60495, 60496, 60497, 60498	-

41 PCS.

COD.	AF inch	PCS.	Kg
61793	1/2	41	5,5

PCS./UN.	Composición / Composition / Composition	Descripción / Description / Description
18	61382, 61383, 61384, 61385, 61386, 61387, 61388, 61389, 61390, 61391, 61392, 61393, 61394, 61395, 61396, 61399, 61402, 61403	Llaves de vaso / Socket wrenches
15	60481, 60482, 60483, 60484, 60486, 60487, 60488, 60490, 60491, 60492, 60494, 60495, 60496, 60497, 60498	
1	61597	Carraca / Ratchet
2		Alargadera / Extension
	61440	Mango en T / T Handle
1	61437	Articulación universal / Universal joint
	61441	Mango articulado / Hinged handle
2	61462, 61463	Llaves de vaso para bujías / Spark plug socket



10

LLAVES DE VASO
SOCKET WRENCHES
DOUILLES
STECKSCHLÜSSEL
BUSSOLE
CHAVES DE CAIXA
ГОЛОВКИ



1/2"

33 PCS.

COD.		PCS.	
65074	1/2	33	7,0
65075			

PCS./UN.	Composición / Composition / Composition	Descripción / Description / Description					
15	60481, 60482, 60483, 60484, 60486, 60487, 60488, 60490, 60491, 60492, 60494, 60495, 60496, 60497, 60498	Llaves de vaso / Socket wrenches	3/8"-7/16"-1/2"-9/16"-5/8"-11/16"-3/4"-13/16"-7/8"-15/16"-1.1/16"-1.1/8"-1.3/16"-1.1/4"		-	-	-
10	67805, 67806, 67807, 67808, 67809, 67810, 67811, 67812, 67813, 67814	Llaves de vaso serie larga / Long socket wrenches	3/8"-7/16"-1/2"-9/16"-5/8"-11/16"-3/4"-13/16"-7/8"-15/16"		-	-	-
1	61597	Carraca / Ratchet	-		-	-	-
3	61453, 61455, 61458	Alargadera / Extension	3"-5"-10"	-		-	-
1	61441	Mango articulado / Hinged handle	-	-	-		-
1	61437	Articulación universal / Universal joint	-	-	-		-
2	61462, 61463	Llaves de vaso para bujías / Spark plug socket	5/8"-13/16"	-	-	-	



3/4"

14 PCS.

COD.		PCS.	
61861	3/4	14	12
61862			

PCS./UN.	Composición / Composition / Composition	Descripción / Description / Description				
10	65027, 60528, 60529, 60531, 60532, 60535, 60536, 60537, 60539, 60541	Llaves de vaso / Socket wrenches	7/8"-15/16"-1"-1.1/8"-1.1/4"-1.7/16"-1.1/2"-1.5/8"-1.13/16"-2"		-	-
1	61863	Carraca / Ratchet	-		-	-
2	61865, 61866	Alargadera / Extension	4"-8"	-		-
1	61864	Mango en T / T Handle	-	-	-	



1"

14 PCS.

COD.		PCS.	
65041	1	14	27
65042			

PCS./UN.	Composición / Composition / Composition	Descripción / Description / Description				
10	65037, 65038, 65036, 65023, 65024, 65025, 65027, 65028, 65029, 65030, 65031, 65032, 65034	Llaves de vaso / Socket wrenches	1.13/16"-1.7/8"-2"-2.3/16"-2.1/4"-2.3/8"-2.1/2"-2.5/8"-2.3/4"-3.1/8"		-	-
1	65035	Carraca / Ratchet	-		-	-
2	65037, 65038	Alargadera / Extension	8"-16"	-		-
1	65036	Mango en T / T Handle	-	-	-	





■ EXPOSITORES / DISPLAYS / PRESENTOIRS / DISPLAY / ESPOSITORE / DISPLAY STAND / СТЕНДЫ

■ 1/2"



■ 233 PCS.

COD.		PCS.
65296	1/2	233

PCS./UN.	Composición / Composition / Composition	Descripción / Description / Description	
96	61800, 61801, 61802, 61803, 61804, 61805, 61806, 61807	8-9-10-11-12-13-14-15 mm	
22	61808, 61809	16-17 mm	
20	61810, 61811	18-19 mm	
18	61812, 61813	20-21 mm	
24	61814, 61815, 61816	22-23-24 mm	
35	61817, 61818, 61819, 61820, 61821	25-26-27-28-29 mm	
12	61822, 61823	30-32 mm	
6	61430	Carraca / Ratchet	





COD.		PCS.
65297	1/2	233

PCS./UN.	Composición / Composition / Composition	Descripción / Description / Description	
96	61380, 61381, 61382, 61383, 61384, 61385, 61386, 61387	8-9-10-11-12-13-14-15 mm	
22	61388, 61389	16-17 mm	
20	61390, 61391	18-19 mm	
18	61392, 61393	20-21 mm	
24	61394, 61395, 61391	22-23-24 mm	
35	61397, 61398, 61399, 61400, 61401	25-26-27-28-29 mm	
12	61402, 61403	30-32 mm	
6	61431	Carraca / Ratchet	





■ 236 PCS.

COD.		PCS.
65298	1/2	236

PCS./UN.	Composición / Composition / Composition	Descripción / Description / Description	
48	60460, 60461	5/16"-3/8"	
24	60462, 60463	7/16"-1/2"	
	60464	9/16"	
22	60466	5/8"	
20	60467	11/16"	
19	60468	3/4"	
9	60470	13/16"	
16	60471	7/8"	
8	60472	15/16"	
	60474	1"	
14	60475, 60476	1.1/16"-1.1/8"	
12	60477, 60478	1.3/16"-1.1/4"	
6	61430	Carraca / Ratchet	

1/2"

COD.		PCS.
65299	1/2	236

PCS./UN.	Composición / Composition / Composition	Descripción / Description / Description	
48	60480, 60481 60482, 60483, 60484, 60485	5/16"-3/8" 7/16"-1/2"-9/16"-19/32"	
22	60486, 60479	5/8"-21/32"	
20	60487	11/16"	
10	60488	3/4"	
18	60489, 60490	25/32"-13/16"	
16	60491	7/8"	
8	60492	15/16"	
28	60493, 60494, 60495, 60496	31/32"-1"-1.1/16"-1.1/8"	
12	60497, 60498	1.3/16"-1.1/4"	
6	61431	Carraca / Ratchet	

3/4"

86 PCS.

COD.	PCS.
65300	86

PCS./UN.	Composición / Composition / Composition	Descripción / Description / Description	
35	60501, 60503, 60505, 60507, 60508	19-22-24-26-27 mm	
18	60510, 60511, 60512	29-30-32 mm	
25	60514, 60515, 60516, 60517, 60519	34-35-36-38-41 mm	
8	60521, 60522	46-50 mm	



COD.	PCS.
65301	86

PCS./UN.	Composición / Composition / Composition	Descripción / Description / Description	
14	60527	7/8"	
21	60528, 60529, 60530	15/16"-1"-1.1/16"	
6	60531	1.1/8"	
12	60532	1-1/4"	
25	60533, 60534, 60535, 60536, 60537	1.5/16"-1.3/8"-1.7/16"-1.1/2"-1.5/8"	
8	60539, 60541	1.13/16"-2"	

LLAVES DE VASO DE IMPACTO / IMPACT SOCKET WRENCHES / DOUILLES À CHOC / KRAFTSCHRAUBEREINSATZ / BUSSOLA AD IMPULSI / CHAVES DE CAIXA DE IMPACTO / УДАРНЫЕ ГОЛОВКИ

- 3/8"
- 6 PT.
- STANDARD
- MM

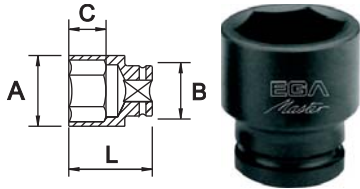

COD.	AF mm	L (mm)	A (mm)	B (mm)	C (mm)	Pt	g	
60590	7		12				41	
60591	8		13					
60592	9		14	19	14		43	
60593	10		16					
60594	11		17				44	
60595	12		18					
60596	13	30	20	20	15	6		6
60597	14		21	21				
60598	15		22	22			60	
60599	16		23	23	16			
60600	17		24	24				
60601	18		26	26				
60602	19		27	27			70	

● DIN 3129

CARACTERÍSTICAS / FEATURES / CARACTÉRISTIQUES

Cr-V

■ INCH

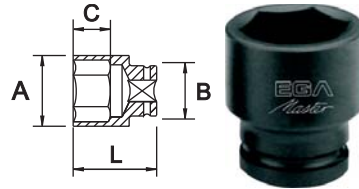

COD.	AF inch	L (mm)	A (mm)	B (mm)	C (mm)	Pt	g	
65205	5/16		13				43	
65206	3/8		15	19	14			
65207	7/16		17				44	
65208	1/2		19		15			
65209	9/16		21	21		6	60	6
65210	5/8	30	23	23				
65211	11/16		25	25	16			
65212	3/4		27	27			70	
68685	13/16		30	30			100	
68686	7/8		32	32			125	

● DIN 3129

CARACTERÍSTICAS / FEATURES / CARACTÉRISTIQUES

Cr-V

PUNTAS ATORNILLADORAS DE IMPACTO CON VASO / IMPACT SOCKET BITS / EMBOUTS SUR DOUILLE MONOBLOC IMPACT / STECKSCHLÜSSEL BITS / INSERTI A BUSSOLA IMPACT / PONTAS APARAFUSADORAS DE IMPACTO COM CHAVE DE CAIXA / УДАРНАЯ ГОЛОВКА ДЛЯ БИТ

HEXAGONAL / HEXAGONAL / HEXAGONALE / HEXAGONAL / ESAGONALE / HEXAGONAL / ШЕСТИГРАННАЯ

COD.	mm	L (mm)	g		
65920	3		45		
65921	4		50		
65922	5				
65923	6	78	55	10	●
65924	8		65		
65925	10		85		
65926	12		100		
65927	14		120		



TORX®*

COD.		L (mm)	g		
65928	T25		40		
65929	T27	60		10	●
65930	T30		45		
65931	T40				



*Para tornillos TORX® (Marca registrada por Acument Intellectual Properties, LLC, Troy, Mich., US) / *For screws TORX® (Acument Intellectual Properties, LLC, Troy, Mich., US registered trademark) / *Pour vis TORX® (Marque enregistrée par Acument Intellectual Properties, LLC, Troy, Mich., US)

3/8"

COD.		L (mm)			
65932	T45	60	50	10	●
65933	T50		55		
65934	T55		65		
65935	T60		75		

- 1/2"
- 6 PT.
- STANDARD
- MM

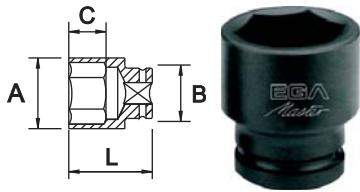

INCH

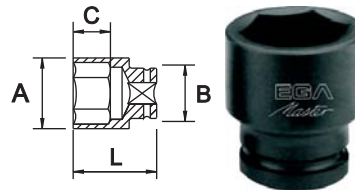

COD.		L (mm)	A (mm)	B (mm)	C (mm)	Pt		
60658	8						6	
57987	9		17				65	1
60603	10							
60604	11		19		15			
60605	12		20	24				
60606	13		22				80	
60607	14							
60608	15		24					
60609	16							
60610	17	38	26	26	16		95	6
60611	18		28	28				
60612	19						110	
60639	20		29	29	18	6		
60613	21		30	30			120	
60614	22		32	32			140	
60615	24		34	34	20		160	
60616	27		38				185	
57988	28		40	35	21		188,2	1
60617	29						200	
60618	30	43	42	42	20		210	6
60619	32	38	44	35				
57989	33		46,5	30			236	1
57990	34	48	46,8		23		248	
60712	36	50	50	36			350	6

DIN 3129

CARACTERÍSTICAS / FEATURES / CARACTÉRISTIQUES

Cr-V

COD.		L (mm)	A (mm)	B (mm)	C (mm)	Pt		
65213	3/8		16					
65214	7/16		18					
65215	1/2		20	23	14		85	
65216	9/16		22					
65217	5/8		24	24	15			
65218	11/16		26	26				
65219	3/4		28	28	16		125	6
65220	13/16	38	30	30	19	6		
65221	7/8		32	32			130	
65222	15/16		34	34	20		135	
65223	1		36				145	
65224	1.1/16		38				170	
65225	1.1/8		40	35	21		190	1
57985	1.3/16		42					
65226	1.1/4		44				200	6

DIN 3129

CARACTERÍSTICAS / FEATURES / CARACTÉRISTIQUES

Cr-V

1/2"

■ **SERIE LARGA / LONG SOCKETS / SÉRIE LONGUE / LANGE SERIE / SERIE LUNGA / SERIE LONGA / ВЫСОКАЯ СЕРИЯ**

■ **MM**

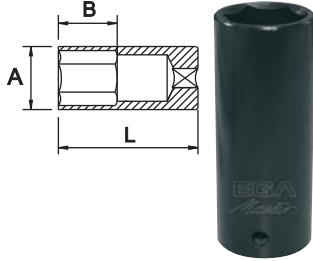

■ **INCH**

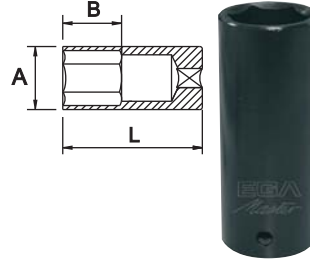

COD.	AF _{mm}	L (mm)	A (mm)	B (mm)	Pt	g	Icons
57994	9		16	24		142	1
60660	10		17				
60661	11		18	27			
60662	12		19				
60663	13		20			190	6
60664	14		22				
60665	16		24				
60666	17		26				
60667	18		27				
60668	19	80	28				
57995	20		30		6	260	1
60669	21		31	37			
60670	22		32			310	
60671	23		33			320	
60672	24		34			340	6
60673	27		38			400	
60674	29		40			420	
60675	30		42			430	
60676	32		44			450	
57996	34		47	38		503	1

○ I DIN 3129

CARACTERÍSTICAS / FEATURES / CARACTÉRISTIQUES

Cr-V

COD.	AF _{inch}	L (mm)	A (mm)	B (mm)	Pt	g	Icons
55630	3/8		18	24			
55631	7/16						
55632	1/2		20			190	
55633	9/16		22	29			
55634	5/8		24				
55635	11/16		26				
55636	3/4		28			220	6
55637	13/16	80	30		6	250	
55638	7/8		32			290	
55639	15/16		34			320	
55640	1		36	36			
55641	1.1/16		38			370	
55642	1.1/8		40				
57992	1.3/16		42			386	1
55643	1.1/4		44			420	6

○ I DIN 3129

CARACTERÍSTICAS / FEATURES / CARACTÉRISTIQUES

Cr-V

1/2"

- 8 PT.
- STANDARD
- INCH

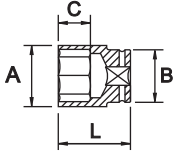

COD.	AF inch	L (mm)	A (mm)	B (mm)	C (mm)	Pt	g		
56350	3/8	38	19	24	6	8	70	6	●
56351	7/16		21		8		75		
56352	1/2		24		9		80		
56353	9/16		26		26		95		
56354	5/8		28		28		110		
56355	11/16	30	30	125					
56356	3/4	40	34	34	13	8	180	6	●
56357	13/16		36	36	15		195		
56358	7/8		38	18	220				
56359	15/16	45	42	38	18	8	285	6	●
56360	1		44	300					
56361	1.1/16	50	46.5	46.5	19	8	430	6	●
56362	1.1/8		49	49			605		



CARACTERÍSTICAS / FEATURES / CARACTÉRISTIQUES

Cr-V

PUNTAS ATORNILLADORAS DE IMPACTO CON VASO / IMPACT SOCKET BITS / EMBOUTS DE VISSAGE CHOCS À DOUILLE / STECKSCHLÜSSEL BITS / INSERTI A BUSSOLA IMPACT / PONTAS APARAFUSADORAS DE IMPACTO COM CHAVE DE CAIXA / УДАРНАЯ ГОЛОВКА ДЛЯ БИТ

HEXAGONAL / HEXAGONAL / HEXAGONALE / HEXAGONAL / ESAGONALE / HEXAGONAL / ШЕСТИГРАННАЯ

COD.	mm	L (mm)	g		
65936	4	78	80	10	●
65937	5		85		
65938	6		95		
65939	8		110		
65940	10		120		
65941	11		125		
65942	12		140		
65943	14		170		
65944	17		200		
65945	19				



TORX®*

COD.		L (mm)	g		
65946	T25	78	75	10	●
65947	T27		80		
65948	T30				
65949	T40				
65950	T45		85		
65951	T50		90		
65952	T55		110		
65953	T60		120		



*Para tornillos TORX® (Marca registrada por Acument Intellectual Properties, LLC, Troy, Mich., US) / *For screws TORX® (Acument Intellectual Properties, LLC, Troy, Mich., US registered trademark) / *Pour vis TORX® (Marque enregistrée par Acument Intellectual Properties, LLC, Troy, Mich., US)

- 3/4"
- 4 PT.
- STANDARD
- MM

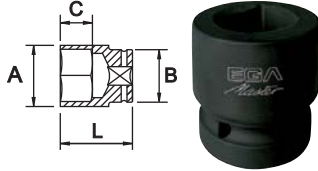

- INCH

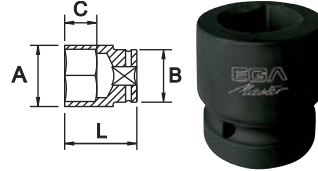

COD.	AF mm	L (mm)	A (mm)	B (mm)	C (mm)	Pt	g	
57190	22		44				240	
57191	24	50	47	44	24	4	250	1
57192	27		49				270	
57193	30		55				420	

COD.	AF inch	L (mm)	A (mm)	B (mm)	C (mm)	Pt	g	
56394	5/8		32	40	13		285	
56395	11/16	52	34	40	13	4	295	1
56396	13/16		42	42	15		380	



CARACTERÍSTICAS / FEATURES / CARACTÉRISTIQUES

Cr-V



CARACTERÍSTICAS / FEATURES / CARACTÉRISTIQUES

Cr-V

EGA Master

ART IN INNOVATION

3/4"

- 6 PT.
- STANDARD
- MM

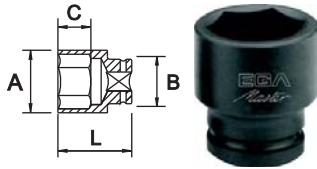

COD.	AF mm	L (mm)	A (mm)	B (mm)	C (mm)	Pt	g	
63879	17		30				220	
60620	19		33					
57335	20		35		18			
60621	21		35					
60622	22	50	37	38				
60623	23		38				230	
60624	24		39		22			
57336	25		40		23			
60625	26		41		24			
60626	27		43		26			
60627	28		44	40				
60628	29		45	42			310	
60629	30		46				420	
57337	31		46				430	
60630	32		49				440	
60631	33		50				460	
60632	34	55	50		27	6	480	1
60633	36						500	
60634	38		55				550	
57338	39			44			560	
57339	40						570	
60635	41						600	
60636	42		60					
57340	44	60						
57341	45						700	
60637	46	65	65					
57342	47				28			
63880	48							
60638	50	70	70				1100	
57345	51							
63881	54			55	32			
63891	55	75	75				1250	
63921	60	75	85		43		1300	

⊕ I DIN 3129

CARACTERÍSTICAS / FEATURES / CARACTÉRISTIQUES

Cr-Mo

■ INCH

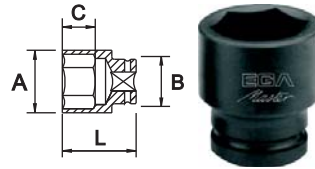

COD.	AF inch	L (mm)	A (mm)	B (mm)	C (mm)	Pt	g	
65227	3/4		33					
65228	13/16		35					
65229	7/8	50	37		18			
65230	15/16		39				230	
65231	1		41		22			
65232	1.1/16		43		26			
65233	1.1/8		45				310	
65234	1.3/16		46				420	
65235	1.1/4	55	49				440	
65236	1.5/16		50	44			460	
65237	1.3/8						480	
65238	1.7/16		55		27		500	
65239	1.1/2					6	550	1
68689	1.9/16		58					
65240	1.5/8	60	60				600	
65241	1.11/16							
65242	1.3/4		65				700	
57344	1.13/16							
65243	1.7/8	65	70					
57346	1.15/16						750	
65244	2				28			
57347	2.1/16	70	75				1100	
57348	2.1/8			55				
68688	2.3/16	75	80				1350	
57999	2.1/4				35		1444	

⊕ I DIN 3129

CARACTERÍSTICAS / FEATURES / CARACTÉRISTIQUES

Cr-Mo

3/4"

■ **SERIE LARGA / LONG SOCKETS / SÉRIE LONGUE / LANGE SERIE / SERIE LUNGA / SERIE LONGA / ВЫСОКАЯ СЕРИЯ**

■ **MM**

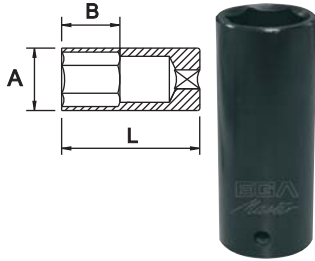

COD.	AF mm	L (mm)	A (mm)	B (mm)	Pt	g	Icon 1	Icon 2
60679	19		33					
57349	20		34					
60680	21		35		600			
60681	22		37	28				
57350	23		39					
60682	24		40					
57351	25		41	36				
60683	26		42	50	650			
60684	27		44					
57352	28		45					
57353	29	90	46	55	6	1		
60685	30		49			850		
60686	32		50			900		
60687	33		55					
60688	34		60			950		
60689	36		65			1000		
60690	38		65			1100		
60691	41		70	70		1200		
63895	42							
63945	44							
63896	48							
63897	50							

⊗ **DIN 3129**

CARACTERÍSTICAS / FEATURES / CARACTÉRISTIQUES

Cr-Mo

■ **INCH**

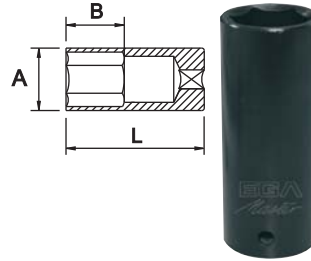

COD.	AF inch	L (mm)	A (mm)	B (mm)	Pt	g	Icon 1	Icon 2
58001	3/4		33			550		
58002	13/16		35					
58003	7/8		37	26	600			
58004	15/16		38			550		
65245	1		40			600		
65246	1.1/16		42			650		
65247	1.1/8		44	28	650			
65248	1.3/16		46			700		
65249	1.1/4		48			750		
65250	1.5/16		50	30	6	800	1	
65251	1.3/8	90	55	34		940		
57360	1.7/16		61	54		1000		
65252	1.1/2		60	42		940		
58005	1.9/16		65	65		1000		
57361	1.5/8		65	42		1100		
57362	1.5/8		70	65		1150		
57363	1.11/16							
58006	1.5/8							
63946	1.3/4							
57364	1.13/16							
57365	1.7/8							
57366	1.15/16							
57367	2							

⊗ **DIN 3129**

CARACTERÍSTICAS / FEATURES / CARACTÉRISTIQUES

Cr-Mo

■ **8 PT.**

■ **STANDARD**

■ **INCH**

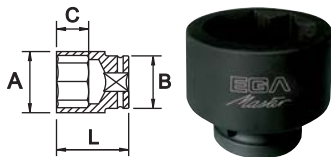

COD.	AF inch	L (mm)	A (mm)	B (mm)	C (mm)	Pt	g	Icon 1
56363	5/8		32				275	
56364	11/16		34	40	13		280	
56365	3/4	50	40				320	
56366	13/16		42	42	15	8	360	1
56367	7/8		44				395	
56368	15/16	52	46	44	18		425	
56369	1		50				485	

⊗

CARACTERÍSTICAS / FEATURES / CARACTÉRISTIQUES

Cr-V

- 1"
- 4 PT.
- STANDARD
- MM

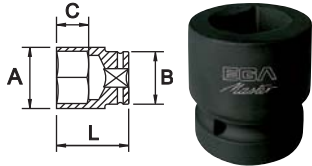

- INCH

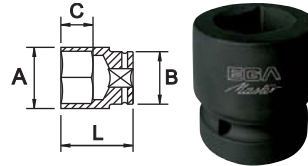

COD.	AF mm	L (mm)	A (mm)	B (mm)	C (mm)	Pt	g	
57194	17		40				320	
57195	18		42				340	
57196	20			50	24		350	
57197	21		44				360	
57198	22	60				4	370	1
57199	23		48					
57200	24		50				500	
57201	27		55	55	27			
57202	30		60				550	

COD.	AF inch	L (mm)	A (mm)	B (mm)	C (mm)	Pt	g	
56397	3/4		43		13		575	
56398	13/16	57	44	52			565	
56399	7/8		48		15		675	
56400	15/16	60	50		18	4	685	1
56401	1		53	54			715	
56402	1.1/8		60		19		840	
56403	1.1/2	75	75		24		1445	



CARACTERÍSTICAS / FEATURES / CARACTÉRISTIQUES

Cr-V

CARACTERÍSTICAS / FEATURES / CARACTÉRISTIQUES

Cr-V

EGA Master

ART IN INNOVATION

10

**LLAVES DE VASO
SOCKET WRENCHES
DOUILLES
STECKSCHLÜSSEL
BUSSOLE
CHAVES DE CAIXA
ГОЛОВКИ**



1"

- 6 PT.
- STANDARD
- MM

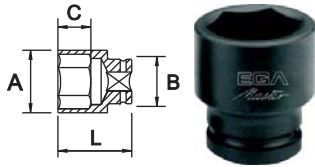

■ INCH

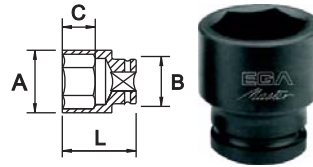

COD.	AF mm	L (mm)	A (mm)	B (mm)	C (mm)	Pt	g	
57372	20		37					
57373	21		38				500	
57374	22		39					
57375	23	60	40					
65534	24							
57376	25		42	50	23			
57377	26		44					
65535	27		45				550	
57378	28		46					
57379	29		48					
65536	30		49					
57380	31		50					
65537	32						600	
57140	33							
57141	34	65	53		26		650	
57142	35							
65538	36		55				700	
57381	37							
60640	38		60				800	
57382	39							
63882	40				28	6	850	1
60641	41		65					
60642	42							
57383	44	70					900	
57384	45			55			950	
60643	46							
57385	47	75	75				1050	
63890	48				32			
60644	50							
60645	52						1100	
60646	54	80					1150	
60647	55		80		45		1200	
60648	56						1250	
60649	57	85					1300	
60650	58		85				1350	
60651	60				47		1450	
60652	62	90	90					
60653	63						1550	
60654	65	95	95					
60655	70		100		50		1700	
60656	75	100	105	85	55		3600	
63925	80		110				3700	

DIN 3129

CARACTERÍSTICAS / FEATURES / CARACTÉRISTIQUES

Cr-Mo

COD.	AF inch	L (mm)	A (mm)	B (mm)	C (mm)	Pt	g	
58008	3/4		34				504	
58009	13/16		36			17	529	
58010	7/8	58	40	54			544	
58011	15/16		42			18	561	
65253	1		44			26		
65254	1.1/16		46				550	
65255	1.1/8		48				600	
65256	1.3/16		49				650	
65257	1.1/4	60	50				700	
65258	1.5/16				27			
57143	1.11/32		55				750	
65259	1.3/8							
65260	1.7/16							
65261	1.1/2	65	60				800	
65262	1.9/16							
65263	1.5/8				28		850	
65264	1.11/16	70	65					
65265	1.3/4						900	
65266	1.13/16		70	55		6	950	1
65267	1.7/8	75					1000	
68690	1.15/16				32		1100	
65268	2		75					
68691	2.1/16	80						
65269	2.1/8		80				1400	
65270	2.1/4	85						
68692	2.5/16		85					
65271	2.3/8						1700	
68693	2.7/16	90	90		47		2000	
65272	2.1/2							
68694	2.9/16							
65273	2.5/8	95	95				2200	
58012	2.11/16		97				2256	
58013	2.3/4		99				2560	
58014	2.13/16		101				3237	
58015	2.7/8	100	103	86	53		3392	
58016	2.15/16		104				3486	

DIN 3129

CARACTERÍSTICAS / FEATURES / CARACTÉRISTIQUES

Cr-Mo

1"

■ **SERIE LARGA / LONG SOCKETS / SÉRIE LONGUE / LANGE SERIE / SERIE LUNGA / SERIE LONGA / ВЫСОКАЯ СЕРИЯ**

■ **MM**

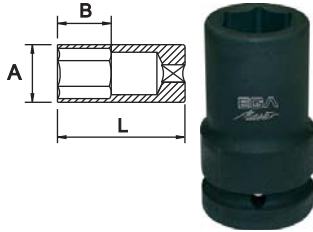

■ **INCH**

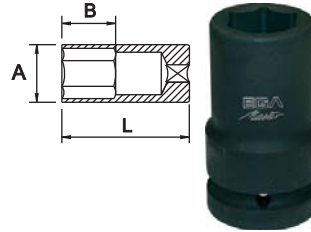

COD.	AF mm	L (mm)	A (mm)	B (mm)	Pt	g		
57386	20					700		
57387	21		40			750		
63898	22			16				
63899	23		41			800		
65539	24		42					
57388	25		43					
63900	26		44			900		
65540	27		46					
63905	28		47	19		950		
63901	29		48					
65541	30	90	49					
65542	32		50			1000		
63902	33				6		1	●
63903	34		55					
63904	35			23				
65543	36					1050		
65544	38		60			1100		
57392	40					1200		
63883	41					1300		
63906	42		65	40		1500		
63907	43					1600		
65546	46		70			1900		
57393	47	100				2500		
65547	50		75					
63908	55		80	50				
63909	60	120	90					

● | DIN 3129

CARACTERÍSTICAS / FEATURES / CARACTÉRISTIQUES

Cr-Mo

COD.	AF inch	L (mm)	A (mm)	B (mm)	Pt	g		
57398	1		43			800		
57399	1.1/16		45	30		850		
58018	3/4		34			792		
58019	13/16		36	19		822		
58020	7/8		40			854		
58021	15/16		42			879		
65274	1.1/8		48					
65275	1.3/16		49	30		1200		
65276	1.1/4		50					
65277	1.5/16							
65278	1.3/8		55	35		1250		
65279	1.7/16					1300		
65280	1.1/2		60			1350		
65281	1.9/16			6	6	1400	1	●
65282	1.5/8		65			1450		
65283	1.11/16	110				1550		
65284	1.3/4		70	42		1600		
65285	1.13/16					1650		
65286	1.7/8					1700		
57400	1.15/16		75			1800		
65287	2					1745		
58022	2.1/16		78					
58023	2.1/8		80	57		1913		
58024	2.3/16		83			2066		
58025	2.1/4		86			2176		
58026	2.5/16	120	87	58		2393		
58027	2.3/8							

● | DIN 3129

CARACTERÍSTICAS / FEATURES / CARACTÉRISTIQUES

Cr-Mo

1"

- 8 PT.
- STANDARD
- INCH

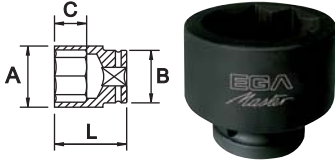

COD.	AF inch	L (mm)	A (mm)	B (mm)	C (mm)	Pt	g	
56377	7/8		50		15		695	
56378	15/16	60	52		18		700	
56379	1		54				715	
56380	1.1/8		59	54	19		820	
56381	1.3/16		61		21		850	
56382	1.1/4	62	63				860	
56383	1.5/16		66		22		905	
56384	1.3/8	65	68				1085	
56385	1.7/16	67	71	58	24	8	1200	1
56386	1.1/2		73				1225	
56387	1.5/8	70	78				1365	
56388	1.11/16	74	82		27		1710	
56389	1.3/4		84				1720	
56390	1.13/16	76	86	62	30		1830	
56391	1.7/8		88				1850	
56392	2	80	94		32		2200	
56393	2.3/16	84	101		35		2655	



CARACTERÍSTICAS / FEATURES / CARACTÉRISTIQUES

Cr-V

- 1.1/2"
- 6 PT.
- STANDARD
- MM

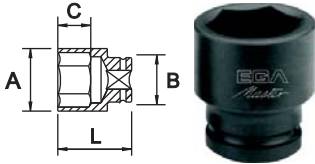

COD.	AF mm	L (mm)	A (mm)	B (mm)	C (mm)	Pt	Kg		
63884	34								
65666	35		60				2,2		
65737	36								
63885	38	80							
63886	40				31				
63887	41		70						
63888	42						2,4		
63889	43		75						
65426	46	85							
65427	50		80		33				
65428	55	90	85		36		2,7		
65429	60		90		39		2,8		
65430	65	95	95		40		3,2		
65431	70	100	105		40		3,5		
65432	75	105	110		40		4,0		
68697	77		115	85	42	6	4,5	1	-
65433	80								
65434	85	110	120				5,0		
65435	90		130		50		5,5		
65436	95		135				6,0		
65437	100	115	140		55		6,5		
65438	105	120	145				7,5		
65439	110	125	155		70		8,0		
65440	115		160		72		9,0		
65441	120	130	165				10		
65442	125	135	175		77		12		
65443	130	140	180						
65444	135	145	185						
65445	140	150	190		80		14		
65446	145		195				15		
65447	150	155	200		85		15,5		

DIN 3129

CARACTERÍSTICAS / FEATURES / CARACTÉRISTIQUES

Cr-Mo

INCH

COD.	AF inch	L (mm)	B (mm)	C (mm)	Pt	Kg			
58029	1.5/16		86						●
68700	1.3/8						2,2		
68701	1.7/16								
68702	1.1/2	80							
68703	1.9/16			31	6	1			-
68704	1.5/8		85						
68705	1.11/16						2,4		
68706	1.3/4								
68707	1.13/16	85							

COD.	AF inch	L (mm)	B (mm)	C (mm)	Pt	Kg			
68708	1.7/8								
68709	1.15/16		85		31	2,4			
68710	2								
68711	2.1/16								
68712	2.1/8								
68713	2.3/16						2,7		
68714	2.1/4	90			32				
68715	2.5/16								
68716	2.3/8						2,8		
68717	2.7/16								
68718	2.1/2				35				
68719	2.9/16	95					3,2		
68720	2.5/8								
68721	2.11/16				40				
68722	2.3/4	100					3,5		
68723	2.13/16								
68724	2.7/8								
68725	2.15/16	105	85	42		4,0			-
68726	3								
68727	3.1/16								
68728	3.1/8								
68729	3.3/16					4,5			
68730	3.1/4				6			1	
68731	3.5/16								
68732	3.3/8					5,0			
68733	3.7/16	110		50					
68734	3.1/2								
68735	3.9/16					5,5			
68736	3.5/8								
68737	3.11/16								
68738	3.3/4					6,0			
68739	3.13/16								
68740	3.7/8								
68741	3.15/16	115		55		6,5			
68742	4								
58030	4.1/8	120	86			9,0			
58031	4.3/16					10			
58032	4.1/4								
58033	4.5/16	124		70					
58034	4.3/8					11			
58035	4.7/16								●
58036	4.1/2	128	127	72		12			
58037	4.5/8					13			
58038	4.3/4	132		77		14			
58039	5	136				16			

DIN 3129

CARACTERÍSTICAS / FEATURES / CARACTÉRISTIQUES

Cr-Mo

10

**LLAVES DE VASO
SOCKET WRENCHES
DOUILLES
STECKSCHLÜSSEL
BUSSOLE
CHAVES DE CAIXA
ГОЛОВКИ**



1.1/2"

SERIE LARGA / LONG SOCKETS / SÉRIE LONGUE / LANGE SERIE / SERIE LUNGA / SERIE LONGA / ВЫСОКАЯ СЕРИЯ

MM

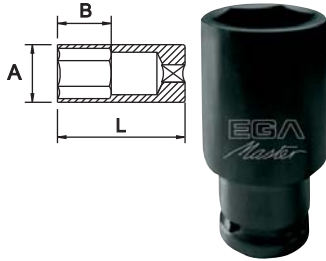

COD.	AF mm	L (mm)	A (mm)	B (mm)	Pt	Kg		
56100	34							
56101	35					2,8		
56102	36		60					
56103	38					2,9		
56104	40	120		31		3,0		
56105	41		70					
56106	42					3,2		
56107	43					3,3		
56108	46		75			3,8		
56109	50		80	33		4,0		
56110	55	150	85	36		4,5		
56111	60		90	39		5,0		
56112	65		95			5,5		
56113	70		105	40		6,5		
56114	75	170	110			7,0		
56115	77		115	42	6	7,5	1	•
56116	80		120			8,0		
56117	85		120	50		8,5		
56118	90	180	130			9,0		
56119	95		135	55		9,5		
56120	100		140			10		
56121	105		145	60		11		
56122	110		155			14		
56123	115	190	160			16		
56124	120		165	75		18		
56125	125		175			19		
56126	130		180			21		
56127	135		185	80		22		
56128	140	200	190			23		
56129	145		195			24		
56130	150		200	85		25		

DIN 3129

CARACTERÍSTICAS / FEATURES / CARACTÉRISTIQUES

Cr-Mo

INCH

COD.	AF inch	L (mm)	A (mm)	B (mm)	Pt	Kg		
58041	1.5/16		62			2,7		
56131	1.3/8					2,8		
56132	1.7/16		65					
56133	1.1/2					2,9		
56134	1.9/16	120		31	6	3,0	1	•
56135	1.5/8		70					
56136	1.11/16					3,1		
56137	1.3/4		75			3,2		

DIN 3129

CARACTERÍSTICAS / FEATURES / CARACTÉRISTIQUES

Cr-Mo

COD.	AF inch	L (mm)	A (mm)	B (mm)	Pt	Kg		
56138	1.13/16							
56139	1.7/8		75	31		3,8		
56140	1.15/16							
56141	2			33		4,0		
56142	2.1/16		80					
56143	2.1/8		85	36				
56144	2.3/16					4,5		
56145	2.1/4	150						
56146	2.5/16		90					
56147	2.3/8			39		5,0		
56148	2.7/16							
56149	2.1/2		95					
56150	2.9/16					5,5		
56151	2.5/8		100			6,0		
56152	2.11/16			40				
56153	2.3/4		105			6,5		
56154	2.13/16							
56155	2.7/8	170						
56156	2.15/16					7,0		
56157	3		110	42				
56158	3.1/16							
56159	3.1/8		115		6	8,0	1	•
56160	3.3/16							
56161	3.1/4		120					
56162	3.5/16			50		8,5		
56163	3.3/8		125					
56164	3.7/16					9,0		
56165	3.1/2							
56166	3.9/16	180						
56167	3.5/8		130					
56168	3.11/16			55				
56169	3.3/4		135			9,5		
56170	3.13/16							
56171	3.7/8					10,0		
56172	3.15/16		140			10,5		
56173	4							
58042	4.1/16		143			11		
58043	4.1/8		146			12		
58044	4.3/16		148	60		13		
58045	4.1/4		151			14		
58046	4.5/16	190				16		
58047	4.3/8		156			17		
58048	4.1/2		160			18		
58049	4.5/8		163					
58050	4.3/4		166	77				

DIN 3129

- 2.1/2"
- 6 PT.
- STANDARD
- MM

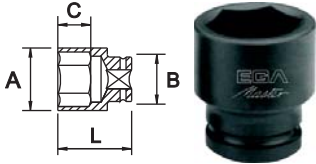

COD.	AF mm	L (mm)	A (mm)	B (mm)	C (mm)	Pt	Kg		
68817	41		80						
68818	42								
68819	46		85						
68820	50	120	90		36				
68821	55		95				7,5		
68822	60		100						
68823	65		105						
65452	70		110		40				
65453	75	125	120		45				
65454	80		125				8,0		
65455	85	130	130		50		8,5		
65456	90		135		55		9,0		
65457	95	140	140		60		11		
65458	100		145		65				
65459	105	145	155		70		13		
65460	110	155	160		75				
65461	115	160	165		80		15		
65462	120	165	175		85		16		
65463	125	165	180	130	90	6	18	1	-
65464	130	170	185		95		19		
65465	135	175	190		100				
65466	140	180	200		105		20		
65467	145	185	210		110		21		
65468	150	190	220		115		25		
65469	155	195	230		120		28		
65470	160	200	240		125		30		
65471	165				130		32		
65472	170	210	240		135		35		
65473	175				140		37		
65474	180		250		145		40		
65475	185	220	260		150		43		
65476	190		270		155		46		
65477	200		280		160		49		
68824	205				165		55		
68825	210	230	290		170		60		
68826	215				175				
68827	220		300		180		65		
68828	225		310		185				

 DIN 3129

CARACTERÍSTICAS / FEATURES / CARACTÉRISTIQUES

Cr-Mo

2.1/2"

INCH

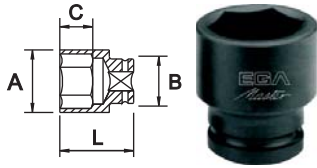

COD.	AF inch	L (mm)	A (mm)	B (mm)	C (mm)	Pt	Kg		
68744	2								
68745	2.1/16		90						
68746	2.1/8								
68747	2.3/16		95						
68748	2.1/4				36				
68749	2.5/16	120				7,5			
68750	2.3/8		100						
68751	2.7/16								
68752	2.1/2								
68753	2.9/16		105						
68754	2.5/8								
68755	2.11/16				40				
68756	2.3/4		110			7,6			
68757	2.13/16								
68758	2.7/8		115						
68759	2.15/16				45	7,7			
68760	3	125	120						
68761	3.1/16								
68762	3.1/8					7,8			
68763	3.3/16								
68764	3.1/4		125						
68765	3.5/16				50				
68766	3.3/8		130			8,4			
68767	3.7/16	130							
68768	3.1/2								
68769	3.9/16		135			8,8			
68770	3.5/8			130		6	1	-	
68771	3.11/16				55				
68772	3.3/4		140			11			
68773	3.13/16	140							
68774	3.7/8		145						
68775	3.15/16								
68776	4		150		60				
68777	4.1/16								
68778	4.1/8	145	155			13			
68779	4.3/16								
68780	4.1/4								
68781	4.5/16	155	160		65				
68782	4.3/8								
68783	4.1/2								
68784	4.9/16		165			15			
68785	4.5/8	160	170		70				
68786	4.11/16								
68787	4.3/4		175			16			
68788	4.13/16								
68789	4.7/8	165	180		75	18			
68790	4.15/16								
68791	5	170	185			19			
68792	5.1/4								
68793	5.5/16	175	190		80				
68794	5.3/8								
68795	5.1/2	180	200			20			
68796	5.3/4	185	210		85				
68797	6								

COD.	AF inch	L (mm)	A (mm)	B (mm)	C (mm)	Pt	Kg		
68798	6.1/4			220					
68799	6.5/16					90	28		
68800	6.3/8	200	230						
68801	6.1/2						30		
68802	6.3/4	210	240		95		32		
68803	7						35		
68804	7.1/4		250		110				
68805	7.5/16						40		
68806	7.3/8	220	260						
68807	7.1/2			130		6	1	-	
68808	7.3/4		270				43		
68809	8		280				49		
68810	8.1/4				120		55		
68811	8.5/16								
68812	8.3/8	230	290				60		
68813	8.1/2								
68814	8.3/4		300				65		
68815	9								

| DIN 3129

CARACTERÍSTICAS / FEATURES / CARACTÉRISTIQUES

Cr-Mo

- 3.1/2"
- 6 PT.
- STANDARD
- MM

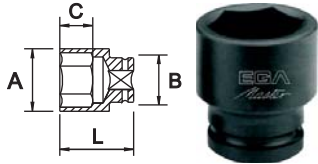

- INCH

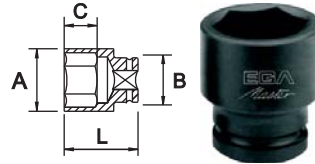

COD.	AF mm	L (mm)	A (mm)	B (mm)	C (mm)	Pt	Kg		
67500	100		170				16		
67501	105	180	175		100		17		
67502	110		185				21		
67503	115	200	190		115		24		
67504	120		195				25		
67505	125		200	180			28		
67506	130	210	210		120		30		
67507	135		220		125		34		
67508	140				130		37		
67509	145	220	230				39		
67510	150		240		135		43		
67511	155						45		
67512	160		250				50		
67513	165	230	260		140		55		
67514	170						60		
67515	175		270	200	145		60		
67516	180		280		150		65		
67517	185	240				6	65	1	-
67518	190		290		155		70		
67519	195		300				70		
67520	200		310		160		80		
67521	205	250					80		
67522	210		320		165		85		
67523	215		330				90		
67524	220	260	340		170		95		
67525	225						105		
67526	230		350		175		110		
67527	235	270	360				110		
67528	240		370	230	185		115		
67529	245						120		
67530	250	280	380		190		125		
67531	255		390				130		
67532	260		400		195		135		
67533	265	290	410				140		
67534	270		420		200		145		
67535	275						150		
67536	280	300	430				150		

DIN 3129

CARACTERÍSTICAS / FEATURES / CARACTÉRISTIQUES

Cr-Mo

COD.	AF inch	L (mm)	A (mm)	B (mm)	C (mm)	Pt	Kg		
68830	4		170				16		
68831	4.1/16		175				17		
68832	4.1/8						21		
68833	4.3/16	180	180		100		24		
68834	4.1/4						25		
68835	4.5/16		185				28		
68836	4.3/8						30		
68837	4.1/2						34		
68838	4.9/16		190				37		
68839	4.5/8						39		
68840	4.11/16		195		115		43		
68841	4.3/4	210		180			45		
68842	4.13/16		200				50		
68843	4.7/8						55		
68844	4.15/16				120		60		
68845	5		210				60		
68846	5.1/4						65		
68847	5.5/16		220		125		65		
68848	5.3/8	220					70		
68849	5.1/2				130		70		
68850	5.3/4		230		135		80		
68851	6		240				80		
68852	6.1/4						85		
68853	6.5/16	230	250		140	6	85	50	1
68854	6.3/8						90		
68855	6.1/2		260				95		
68856	6.3/4						105		
68857	7		270	200	145		105		
68858	7.1/4	240	280				110		
68859	7.5/16				150		115		
68860	7.3/8		290				120		
68861	7.1/2						125		
68862	7.3/4	250	300		155		130		
68863	8		310		160		135		
68864	8.1/4						140		
68865	8.5/16		320		165		140		
68866	8.3/8	260					145		
68867	8.1/2		330				150		
68868	8.3/4				170		155		
68869	9		350				160		
68870	9.1/4	270		230	175		165		
68871	9.5/16		360				170		
68872	9.3/8						175		
68873	9.1/2		370		185		180		
68874	9.3/4	280	380				185		
68875	10		390		190		190		
68876	10.1/4	290	400		195		195		

DIN 3129

CARACTERÍSTICAS / FEATURES / CARACTÉRISTIQUES

Cr-Mo

3.1/2"

ADAPTADOR / ADAPTER / ADAPTATEUR / VERBINDUNGSTEIL / ADATTATORE / REDUTOR / АДАПТЕР

COD.	AF inch	AF inch	g		
60696	3/8-1/2		50		
60698	1/2-3/8		110		
60699	1/2-3/4		130		
60700	3/4-1/2		370		
60701	3/4-1		410		
60702	1-3/4		600	6	•
68698	1-1.1/2		1100		
65448	1.1/2-1		2100		
65449	1.1/2-2.1/2		4000		
65478	2.1/2-1.1/2		4500		

DIN 3121



ARTICULACIÓN UNIVERSAL / UNIVERSAL JOINT / CARDAN UNIVERSEL / KARDANGELNENK / SNODO CARDANICO / CARDAN UNIVERSAL / ШАРНИР

COD.	AF inch	g		
60704	3/8	80	6	•
60705	1/2	180		

DIN 3121



COD.	AF inch	g		
60706	3/4	600	4	
60707	1	1250	2	
60708	1.1/2	3000		•
60709	2.1/2	6000	1	

DIN 3121



ALARGADERA / EXTENSION / RALLONGE / VERLÄNGERUNG / PROLUNGA / EXTENÇÃO / УДЛИНИТЕЛЬ

COD.	AF inch	L (mm)	g		
60710	3/8	75	80		
60711	1/2	125	220		
57368		100	450	6	
60714	3/4	175	850		
57369		250	1050		
60716		175	1500		•
57402	1	250	1850	4	
60717		330	2550		
65450		250	5500		
65451	1.1/2	300	6500	1	

DIN 3121



ANILLA DE SEGURIDAD / SECURITY O-RING / BAGUES DE SECURITE / SICHERUNGSRING / ANELLO SPACCATO / ANEL DE SEGURANÇA / БЕЗОПАСНОЕ КОЛЬЦО

COD.		AF inch	Rango (mm) / Range (mm) / Rang (mm)	g	
60724		3/4	17-46	5,0	
60725			50		
63274	73276		24-38		
60726		1	38-70	10	
60727			75		6
60783		1.1/2	34-150		
63275			41-70		
60784		2.1/2	70-200	20	
63276			200-225		



3.1/2"

PASADOR DE SEGURIDAD / SECURITY PIN / GOUPILLE DE SECURITE / SICHERUNGSTIFT / COPPIGLIA / PINO DE SEGURANÇA / ФИКСИРУЮЩИЙ ПАЛЕЦ

COD.	AF inch	Rango (mm) / Range (mm) / Rang (mm)	g	6
60732	3/4	17-46	10	6
60733		50		
63277	1	24-38	15	6
60734		38-70		
60735		75		
60767	1.1/2	34-150	20	
63278	2.1/2	41-70	25	
60768		70-200		
63279		200-225		



JUEGOS / SETS / COFRETS / SÄTZE / ASSORTIMENTI / JOGOS / НАБОРЫ

1/2"

STANDARD

MM

COD.	AF inch	PCS.	Pt	Kg
60693	1/2	10	6	3,5
61265				3,0



Composición / Composition / Composition	Descripción / Description / Description
60603, 60604, 60605, 60606, 60607, 60610, 60612, 60613, 60614, 60615	Llaves de vaso serie larga / Long socket wrenches

INCH

COD.	AF inch	PCS.	Pt	Kg
61267	1/2	11	6	3,2



Composición / Composition / Composition	Descripción / Description / Description
65213, 65214, 65215, 65216, 65217, 65218, 65219, 65220, 65221, 65222, 65223	Llaves de vaso serie larga / Long socket wrenches 3/8"-7/16"-1/2"-9/16"-5/8"-11/16"-3/4"-13/16"-7/8"-15/16"-1"

SERIE LARGA / LONG SOCKETS / SÉRIE LONGUE / LANGE SERIE / SERIE LUNGA / SERIE LONGA / ВЫСОКАЯ СЕРИЯ

MM

COD.	AF inch	PCS.	Kg	Pt
61266	1/2	10	4,0	6



Composición / Composition / Composition	Descripción / Description / Description
60660, 60661, 60662, 60663, 60664, 60666, 60668, 60669, 60670, 60672	Llaves de vaso / Socket wrenches 10-11-12-13-14-17-19-21-22-24 mm

INCH

COD.	AF inch	PCS.	Pt	Kg
61268	1/2	11	6	4,2



Composición / Composition / Composition	Descripción / Description / Description
55630, 55631, 55632, 55633, 55634, 55635, 55636, 55637, 55638, 55639, 55640	Llaves de vaso / Socket wrenches 3/8"-7/16"-1/2"-9/16"-5/8"-11/16"-3/4"-13/16"-7/8"-15/16"-1"

10

LLAVES DE VASO
SOCKET WRENCHES
DOUILLES
STECKSCHLÜSSEL
BUSSOLE
CHAVES DE CAIXA
ГОЛОВКИ



- 3/4"
- STANDARD
- MM

COD.	AF inch	PCS.	Pt	Kg
60694	3/4	8	6	5,0
61269	3/4	8	6	5,0



Composición / Composition / Composition	Descripción / Description / Description
60621, 60622, 60624, 60626, 60629, 60630, 60633, 60635	Llaves de vaso serie larga / Long socket wrenches

- INCH

COD.	AF inch	PCS.	Pt	Kg
61271	3/4	8	6	5,0



Composición / Composition / Composition	Descripción / Description / Description
65231, 65232, 65233, 65235, 65236, 65237, 65238, 65239	Llaves de vaso serie larga / Long socket wrenches 1"-1.1/16"-1.1/8"-1.1/4"-1.5/16"-1.3/8"-1.7/16"-1.1/2"

- SERIE LARGA / LONG SOCKETS / SÉRIE LONGUE / LANGE SERIE / SERIE LUNGA / SERIE LONGA / ВЫСОКАЯ СЕРИЯ

- MM

COD.	AF inch	PCS.	Pt	Kg
61270	3/4	8	6	6,0



Composición / Composition / Composition	Descripción / Description / Description
60680, 60681, 60682, 60684, 60685, 60686, 60689, 60691	Llaves de vaso / Socket wrenches 21-22-24-27-30-32-36-41 mm

- INCH

COD.	AF inch	PCS.	Pt	Kg
61272	3/4	8	6,0	6



Composición / Composition / Composition	Descripción / Description / Description
65245, 65246, 65247, 65249, 65250, 65251, 65252	Llaves de vaso / Socket wrenches 1"-1.1/16"-1.1/8"-1.1/4"-1.5/16"-1.3/8"-1.7/16"-1.1/2"

- 1"

- STANDARD

- MM

COD.	AF inch	PCS.	Pt	Kg
61273	1	9	6	7,5



Composición / Composition / Composition	Descripción / Description / Description
65534, 65535, 65536, 65537, 65538, 60640, 60641, 60643, 60644	Llaves de vaso serie larga / Long socket wrenches 24-27-30-32-36-38-41-46-50 mm

- INCH

COD.	AF inch	PCS.	Pt	Kg
61275	1	9	7,5	6



Composición / Composition / Composition	Descripción / Description / Description
65253, 65255, 65257, 65258, 65261, 65263, 65265, 65267, 65268	Llaves de vaso serie larga / Long socket wrenches 1"-1.1/8"-1.1/4"-1.5/16"-1.1/2"-1.5/8"-1.3/4"-1.7/8"-2"

1"

■ SERIE LARGA / LONG SOCKETS / SÉRIE LONGUE / LANGE SERIE / SERIE LUNGA / SERIE LONGA / ВЫСОКАЯ СЕРИЯ

■ MM

COD.	AF inch	PCS.	Pt	Kg
61274	1	9	6	7,5
Composición / Composition / Composition		Descripción / Description / Description		
65539, 65540, 65541, 65542, 65543, 65544, 63883, 65546, 65547		Llaves de vaso / Socket wrenches		24-27-30-32-36-38-41-46-50 mm



■ INCH

COD.	AF inch	PCS.	Pt	Kg
61276	1	9	11	6
Composición / Composition / Composition		Descripción / Description / Description		
65274, 65276, 65277, 65280, 65282, 65284, 65286, 65287		Llaves de vaso / Socket wrenches		1"-1.1/8"-1.1/4"-1.5/16"-1.1/2"-1.5/8"-1.3/4"-1.7/8"-2"

