

9

LLAVES  
WRENCHES  
CLÉS  
SCHLÜSSEL  
CHIAVI  
CHAVES  
КЛЮЧИ



## LLAVE COMBINADA REVERSIBLE MASTERGEAR REVERSIBLE MASTERGEAR COMBINATION WRENCH CLÉS MIXTES REVERSIBLES MASTERGEAR

El diseño exclusivo de las llaves **MASTERGEAR** provee al profesional más exigente de una llave multiuso para el apriete en los lugares de más difícil acceso y con un cómodo sistema de carraca. Fabricadas en cromo-vanadio, soportan ampliamente los valores de torsión de los estándares de calidad más exigentes. Su carraca de 72 dientes junto con el diseño especial de su cabeza posibilita aprietes en las posiciones más complicadas, necesitando únicamente 5° para ello. Reversibles, Stubby, E-Torx... todo lo necesario para el profesional.

*The exclusive design of the **MASTERGEAR** wrenches, provides the demanding professional with an all-in-one wrench for the most difficult access tightening, with a comfortable ratchet system. Made in chrome vanadium, they easily stand the most restrictive quality standards for torque. Their 72 teeth gear together with the ratchet head design enables tightening in the narrowest places, with only 5° required for such purpose. Reversible, Stubby, E-Torx... all that the demanding professional may need.*

La concepción exclusiva de la clé **MASTERGEAR** fournit au professionnel le plus exigeant une clé multi-usages pour le serrage dans des lieux exigus, avec un système de cliquet. Fabriquées en chrome vanadium, elles supportent amplement les valeurs de torsion que requièrent les standards de qualité les plus exigeants. Son cliquet de 72 dents, combiné à un dessin spécifique de la tête, permet des serrages dans les positions les plus complexes, requerrant uniquement 5° pour agir. Réversibles, Stubby, E-Torx... tout l'indispensable pour le professionnel.

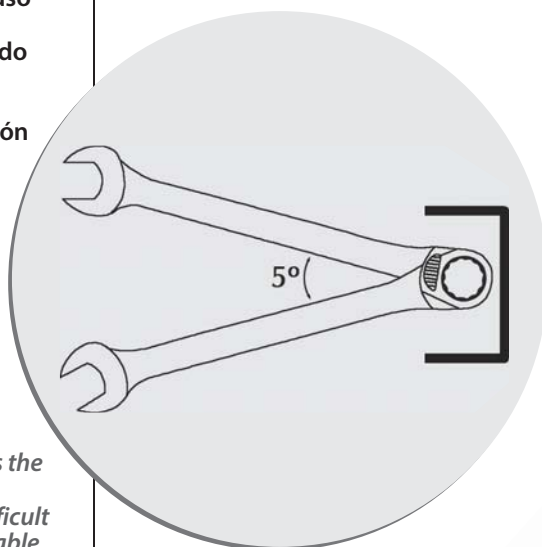

Nuestro objetivo de fabricar herramientas más eficientes y fáciles de usar nos ha llevado a diseñar la palanca de cambio HALF-MOON para las llaves combinadas reversibles **MASTERGEAR**, que evita cambios indeseados y repentinos de dirección de giro durante el uso. Asimismo, está diseñada para evitar el reemplazo prematuro por rotura de palanca, al encontrarse ésta protegida y sin sobresalir del cuerpo de la llave.

*Our aim to make more easy-to-be-used and more efficient items, led us to design the newest HALF-MOON switch for the **MASTERGEAR** Reversible Combination Wrenches, which avoids unwanted or unconscious switch reversing as well as premature damage of the switch. Besides, this switch is designed to avoid the early need to replace it because of breakage, as this switch is protected by the body of the wrench.*

Notre objectif de fabriquer des outils plus performants et plus faciles d'usage, nous a amené à dessiner le bouton de changement de sens de la clé à cliquet réversible **MASTERGEAR**, en forme de demi-lune, ce qui a pour effet d'éviter des changements de sens indésirables et soudain durant l'utilisation. De même, sa conception permet d'éviter des remplacements prématurés de la clé pour cause de rupture du levier, le bouton étant protégé car ne ressortant pas trop du corps de l'outil.

Su innovador diseño de estrella permite apretar múltiples y diferentes cabezas de tornillo, tales como Spline, 6 lados, 12 lados, E-torx y Cuadrados, incluso en cabezas redondeadas hasta en un 50% por el desgaste.

*Its innovative box drive allows to tighten multiple nut heads such as Spline, 6-point, 12 point, Square and E-torx, as well as with 50% rounded off nuts.*

Son dessin innovateur en étoile, permet de serrer de multiples et différentes têtes de vissage, telles que Spline, 6 pans, 12 pans, E-Torx et carrées, y compris des têtes arrondies à 50% par usure.

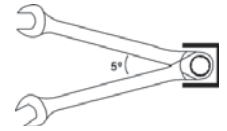
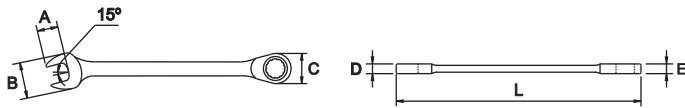

**MASTERGEAR**
**LLAVE COMBINADA DE CARRACA MASTERGEAR / MASTERGEAR COMBINATION RATCHET WRENCH / CLÉ MIXTE A CLIQUET MASTERGEAR / RATSCHEN-RINGGABELSCHLÜSSEL / CHIAVE COMBINATA A CRICCO MASTERGEAR / CHAVE DE BOCA E LUNETA COM ROQUETE MASTERGEAR / КЛЮЧ ТРЕЩЕТОЧНЫЙ КОМБИНИРОВАННЫЙ MASTERGEAR**
**MM**

COD.	L (mm)	AP mm	A (mm)	B (mm)	C (mm)	D (mm)	E (mm)	g		
62651	145	8	9,5	17	18	4,7	7,4	50		
62652	150	9	10	18	19	5,3		55		
62653	160	10	11	22	21	5,7		60		
62654	165	11	12	23	22	6,1		80		
62655	175	12	13	25	23	6,4		90		
62656	180	13	15	26	25	6,6		100		
62657	190	14	16	29	26	7,3		120		10
62658	200	15	17	31	28	7,5		130		
62659	210	16	18	33	29	7,7		150		
62660	230	17	20	36	30	7,9	10,0	180		A
62661	240	18	21	38	32	8,4		200		
62662	250	19	21	39	34	8,7	11,5	240		
62663	270	21	24	43	38	9,5	12,5	310		
62664	280	22	25	46	41	10,0		340		
62665	300	24	26	48	45	11,0	13,5	450		5
62677	340	27	31	55	48	13,0	14,5	600		
62678	370	30	35	62	55	14,0	17,0	800		
62679	400	32	37	64	60	15,0		950		

DIN 1711 | Modelo registrado / Registered model / Modèle enregistré

**CARACTERÍSTICAS / FEATURES / CARACTÉRISTIQUES**

Cr-V

**INCH**

COD.	L (mm)	AP inch	A (mm)	B (mm)	C (mm)	D (mm)	E (mm)	g		
62666	145	5/16	9,0	17	18	4,7	7,4	50		
62667	160	3/8	12	22	21	5,7		60		
62668	165	7/16	12	23	22	6,1		80		
62669	180	1/2	14	26	25	6,6		100		
62670	190	9/16	16	29	26	7,3		120		10
62671	210	5/8	18	33	29	7,7		150		A
62672	230	11/16	20	36	30	7,9	10,0	180		
62673	250	3/4	22	39	34	8,7	11,5	240		
62674	270	13/16	23	43	38	9,5	12,5	310		
62675	280	7/8	26	46	41	10,0	13,5	340		5
62676	300	15/16	27	48	45	11,0		450		

DIN 1711 | Modelo registrado / Registered model / Modèle enregistré

**CARACTERÍSTICAS / FEATURES / CARACTÉRISTIQUES**

Cr-V

A Cromado pulido espejo / Mirror polished chrome plating / Polie chromée / Verchromt geschliffen / Cromate lucide / Cromado polido / Полированный хром

 Si no encuentra el artículo que necesita, consúltenos en [info@egamaster.com](mailto:info@egamaster.com) o en [www.egamaster.com](http://www.egamaster.com)  
 If you can't find the item you look for, please ask us in [info@egamaster.com](mailto:info@egamaster.com) or in [www.egamaster.com](http://www.egamaster.com)  
 Si vous ne trouvez pas l'article que vous desirez, consultez-nous à [info@egamaster.com](mailto:info@egamaster.com) ou à [www.egamaster.com](http://www.egamaster.com)

■ SET

■ MM

COD.		PCS.	
<b>69864</b>	A	10	1000
<b>69865</b>		6	800
<b>Composición / Composition / Composition</b>			
62651, 62652, 62653, 62654, 62655, 62656, 62660, 62662		8-10-12-13-17-19 mm	



■ MM

COD.		PCS.	
<b>69868</b>	A	16	2000
<b>69869</b>		12	1800
<b>Composición / Composition / Composition</b>			
62651, 62652, 62653, 62654, 62655, 62656, 62657, 62658, 62659, 62660, 62661, 62662		8-9-10-11-12-13-14-15-16-17-18-19 mm	



■ INCH

COD.		PCS.	
<b>51453</b>	A	10	1000
<b>51454</b>		6	800
<b>Composición / Composition / Composition</b>			
62666, 62667, 62668, 62669, 62672, 62673		5/16"-3/8"-7/16"-1/2"-11/16"-3/4"	



■ SET DEMO-BLOCK

COD.		
<b>64502</b>	13	300



■ MASTERGEAR REV.



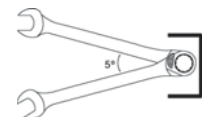
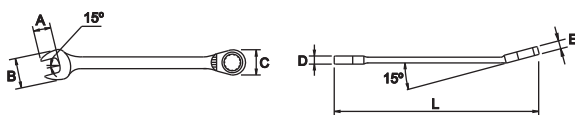

**LLAVE COMBINADA DE CARRACA REVERSIBLE MASTERGEAR / REVERSIBLE MASTERGEAR COMBINATION RATCHET WRENCH / CLÉ MIXTE A CLIQUET RÉVERSIBLE MASTERGEAR / UMKEHRBARE RATSCHEN-GABELSCHLÜSSEL / CHIAVE COMBINATA A CRICCO REVERSIBILE MASTERGEAR / CHAVE DE BOCA E LUNETA DE ROQUETE REVERSIVEL MASTERGEAR / КЛЮЧ РЕВЕРСИВНЫЙ ТРЕЩЕТОЧНЫЙ КОМБИНИРОВАННЫЙ MASTERGEAR**

■ MM



COD.	L (mm)		A (mm)	B (mm)	C (mm)	D (mm)	E (mm)			
<b>62680</b>	145	8	9,5	17	18	4,7		50		
<b>62681</b>	150	9	10	19	19	5,3	7,4	55		
<b>62682</b>	160	10	11	22	21	5,7		60		
<b>62683</b>	165	11	12	23	22	6,1		80		
<b>62684</b>	175	12	13	25	23	6,4		90	10	●
<b>62685</b>	180	13	15	26	25	6,6	8,4	100		
<b>62686</b>	190	14	16	29	26	7,3		120		
<b>62687</b>	200	15	17	31	28	7,5		130		

A Cromado pulido espejo / Mirror polished chrome plating / Polie chromée / Verchromt geschliffen / Cromate lucide / Cromado polido / Полированный хром

COD.	L (mm)		A (mm)	B (mm)	C (mm)	D (mm)	E (mm)			
62688	210	16	18	33	29	7,7	10,0	150		
62689	230	17	20	36	30	7,9	10,0	180	10	
62690	240	18	21	38	32	8,4	11,5	200		
62691	250	19	21	39	34	8,7	11,5	240		● A
62692	270	21	24	43	38	9,5	12,5	310		
62693	280	22	25	46	41	10,0	13,5	340	5	
62694	300	24	26	48	45	11,0	13,5	450		





**DIN 1711** | Modelo registrado / Registered model / Modèle enregistré

**CARACTERÍSTICAS / FEATURES / CARACTÉRISTIQUES**

Cr-V

Reversible / Reversible / Réversible

**INCH**

COD.	L (mm)		A (mm)	B (mm)	C (mm)	D (mm)	E (mm)			
62695	145	5/16	9,0	17	18	4,7	7,4	50		
62696	160	3/8	12	22	21	5,7	8,4	60		
62697	165	7/16	12	23	22	6,1	8,4	80		
62698	180	1/2	14	26	25	6,6	8,4	100	10	
62699	190	9/16	16	29	26	7,3	10,0	120		
62700	210	5/8	18	33	29	7,7	10,0	150		● A
62701	230	11/16	20	36	30	7,9	10,0	180		
62702	250	3/4	22	39	34	8,7	11,5	240		
62703	270	13/16	23	43	38	9,5	12,5	310		
62704	280	7/8	26	46	41	10,0	13,5	340	5	
62705	300	15/16	27	48	45	11,0	13,5	450		

**DIN 1711** | Modelo registrado / Registered model / Modèle enregistré

**CARACTERÍSTICAS / FEATURES / CARACTÉRISTIQUES**

Cr-V

Reversible / Reversible / Réversible

**SET**
**MM**

COD.	PCS.	
69866	10	1000
69867	6	800

**Composición / Composition / Composition**

62680, 62682, 62684, 62685, 62689, 62691

8-10-12-13-17-19 mm

**MM**

COD.	PCS.	
69870	16	2000
69871	12	1800



**Composición / Composition / Composition**

62680, 62681, 62682, 62683, 62684, 62685, 62686, 62687, 62688, 62689, 62690, 62691

8-9-10-11-12-13-14-15-16-17-18-19 mm



**A** Cromado pulido espejo / Mirror polished chrome plating / Polie chromée / Verchromt geschliffen / Cromate lucide / Cromado pulido / Полированный хром



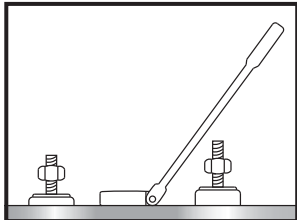
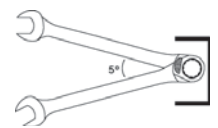
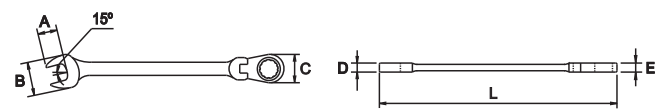

## INCH

COD.		PCS.	
51455	A	10	1000
51456		6	800
Composición / Composition / Composition			
62695, 62696, 62697, 62698, 62701, 62702		5/16"- 3/8"- 7/16"- 1/2"- 11/16"- 3/4"	

**MASTERGEAR ARTICULADA / MASTERGEAR JOINT / MASTERGEAR ARTICULÉE / RATSCHEN-RINGGABELSCHLÜSSEL MIT VERSTELLBAREM KOPF / MASTERGEAR SNODATA / MASTERGEAR ARTICULADA / MASTERGEAR ШАРНИР**

## MM







COD.	L (mm)		A (mm)	B (mm)	C (mm)	D (mm)	E (mm)			
61530	145	8	9,5	17	18	4,7		60		
61531	150	9	10	19	19	5,3	7,4	65		
61532	155	10	11	22	21	5,7		70		
61533	165	11	12	23	22	6,1		90		
61534	170	12	13	25	23	6,4		95		
61535	180	13	15	26	25	6,6	8,4	110		
61536	190	14	16	29	26	7,3		120	10	
61537	200	15	17	31	28	7,5		140		● A
61538	210	16	18	33	29	7,7		160		
61539	230	17	20	36	30	7,9	10,0	190		
61540	240	18		38	32	8,4		210		
61541	250	19	21	39	34	8,7	11,5	240		
61542	270	21	24	43	38	9,5	12,5	250		
61543	280	22	25	46	41	10,0	13,5	350	5	
61544	300	24	26	48	45	11,0		460		

DIN 1711 | Modelo registrado / Registered model / Modèle enregistré





## CARACTERÍSTICAS / FEATURES / CARACTÉRISTIQUES

Cr-V

## INCH

COD.	L (mm)		A (mm)	B (mm)	C (mm)	D (mm)	E (mm)			
61545	145	5/16	9,0	17	18	4,7	7,4	60		
61546	155	3/8	12	22	21	5,7		70		
61547	165	7/16	12	23	22	6,1		90		
61548	180	1/2	14	26	25	6,6	8,4	110	10	● A
61549	190	9/16	16	29	26	7,3		130		
61550	210	5/8	18	33	29	7,7	10,0	170		

A Cromado pulido espejo / Mirror polished chrome plating / Polie chromée / Verchromt geschliffen / Cromate lucide / Cromado polido / Полированный хром

COD.	L (mm)		A (mm)	B (mm)	C (mm)	D (mm)	E (mm)			
61551	230	11/16	20	36	30	7,9	10,0	190	10	
61552	250	3/4	22	39	34	8,7	11,5	250		
61553	270	13/16	23	43	38	9,5	12,5	320		● A
61554	280	7/8	26	46	41	10,0		350	5	
61555	300	15/16	27	48	45	11,0		460		

DIN 1711 | Modelo registrado / Registered model / Modèle enregistré

**CARACTERÍSTICAS / FEATURES / CARACTÉRISTIQUES**

Cr-V

**SET**
**MM**

COD.	PCS.		COD. PCS.	(mm)
69105	6	90080	61530, 61532, 61534, 61535, 61539, 61541	8-10-12-13-17-19
69106	A 8	90081	61530, 61532, 61534, 61535, 61536, 61539, 61541, 61543	8-10-12-13-14-17-19-22
69107	10	90054	61530, 61531, 61532, 61533, 61534, 61535, 61536, 61539, 61541, 61543	8-9-10-11-12-13-14-17-19-22

**INCH**

COD.	PCS.		COD. PCS.	(inch)
69101	6	90080	61546, 61547, 61548, 61549, 61550, 61552	3/8 - 7/16 - 1/2 - 9/16 - 5/8 - 3/4
69102	A 8	90081	61545, 61546, 61547, 61548, 61549, 61550, 61551, 61552	5/16 - 3/8 - 7/16 - 1/2 - 9/16 - 5/8 - 11/16 - 3/4
69103	10	90054	61546, 61547, 61548, 61549, 61550, 61551, 61552, 61553, 61554, 61555	3/8 - 7/16 - 1/2 - 9/16 - 5/8 - 11/16 - 3/4 - 13/16 - 7/8 - 15/16

**MM**

COD.	PCS.	
68525	A	1000
68526		800

**Composición / Composition / Composition**

61530, 61532, 61534, 61535, 61539, 61541

8-10-12-13-17-19 mm

**MM**

COD.	PCS.	
68527	A	2000
68528		1800

**Composición / Composition / Composition**

61530, 61531, 61532, 61533, 61534, 61535, 61536, 61537, 61538, 61539, 61540, 61541

8-9-10-11-12-13-14-15-16-17-18-19 mm



A Cromado pulido espejo / Mirror polished chrome plating / Polie chromée / Verchromt geschliffen / Cromate lucide / Cromado polido / Полированный хром

Si no encuentra el artículo que necesita, consúltenos en [info@egamaster.com](mailto:info@egamaster.com) o en [www.egamaster.com](http://www.egamaster.com)  
If you can't find the item you look for, please ask us in [info@egamaster.com](mailto:info@egamaster.com) or in [www.egamaster.com](http://www.egamaster.com)  
Si vous ne trouvez pas l'article que vous desirez, consultez-nous a [info@egamaster.com](mailto:info@egamaster.com) ou a [www.egamaster.com](http://www.egamaster.com)

**MASTERGEAR STUBBY**

**LLAVE COMBINADA DE CARRACA SERIE CORTA / STUBBY MASTERGEAR COMBINATION RATCHET WRENCH / CLÉ MIXTE À CLIQUET COURTE MASTERGEAR / RATSCHEN-RINGGABELSCHLÜSSEL STUBBY / CHIAVE COMBINATA A CRICCO SERIE CORTA MASTERGEAR / CHAVE DE BOCA E LUNETA ROQUETE SERIE CURTA MASTERGEAR / КЛЮЧ КОРОТКИЙ ТРЕЩЕТОЧНЫЙ КОМБИНИРОВАННЫЙ MASTERGEAR**

■ MM

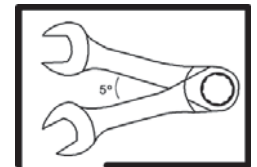
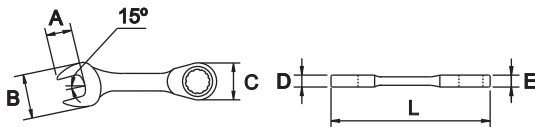

COD.	L (mm)	AP mm	A (mm)	B (mm)	C (mm)	D (mm)	E (mm)	g		
62710	90	8	9,5	17	17	4,0	7,4	29		
62711		9	10	19	19			36		
62712	100	10	11	21	22	4,5		44		
62713		11	12	22	23	5,0		60		
62714	105	12	13	23	25	5,5		8,4		
62715	110	13	15	25	26		6,0	70		
62716	115	14	16	26	30			80	10	● A
62717		15	17	28	31			90		
62718	120	16	18	29	33	7,0		105		
62719		17	20	30	36		10,0	120		
62720	130	18		32	38			140		
62721	135	19	21	34	39	8,0	11,4	160		

DIN 17111 | Modelo registrado / Registered model / Modèle enregistré

**CARACTERÍSTICAS / FEATURES / CARACTÉRISTIQUES**

Cr-V

■ INCH

COD.	L (mm)	AP inch	A (mm)	B (mm)	C (mm)	D (mm)	E (mm)	g		
62722	90	5/16	9,0	17	17	4,0	7,4	29		
62723	100	3/8	12	21	22	4,5		44		
62724	105	7/16		22	23	5,0		60		
62725	110	1/2	14	25	26		6,0	8,4		
62726	115	9/16	16	26	30			80	10	● A
62727	120	5/8	17	29	33	7,0		105		
62728	130	11/16	20	30	36		10,0	120		
62729	135	3/4	22	34	39	8,0	11,4	160		

DIN 17111 | Modelo registrado / Registered model / Modèle enregistré

**CARACTERÍSTICAS / FEATURES / CARACTÉRISTIQUES**

Cr-V



## ■ SET

## ■ MM

COD.		PCS.	
69872		14	1300
69873	A	10	1100





## Composición / Composition / Composition

62712, 62713, 62714, 62715, 62716, 62717, 62718, 62719, 62720, 62721

10-11-12-13-14-15-16-17-18-19 mm



## ■ ADAPTADOR / ADAPTER / ADAPTATEUR / VERBINDUNGSTEILE / ADATTATORE / ADAPTADOR / АДАПТЕР

COD.			L (mm)			
62772	1/4"-10 mm		20	12		
62773	3/8"-17 mm	-	28	39	6	●
62774	1/2"-19 mm		35	65		
62775	-	1/4"-1/4"	25	10		





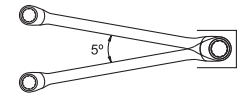
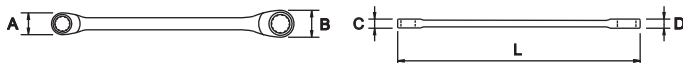

## ■ MASTERGEAR DOUBLE

## ■ LLAVE DE CARRACA DOBLE MASTERGEAR / MASTERGEAR DOUBLE RATCHET WRENCH / CLÉ À DOUBLE CLIQUET MASTERGEAR / MASTERGEAR DOPPEL KNARRE RINGSCHLÜSSEL / CHIAVE DOPPIA A CRICCO / CHAVE DE ROQUETE DUPLO MASTERGEAR / MASTERGEAR КЛЮЧ С ДВОЙНОЙ ТРЕЩЕТКОЙ

## ■ MM



COD.	L (mm)		A (mm)	B (mm)	C (mm)	D (mm)			
63280	185	8-9	18	21	7,4		60		
63281	200	10-11	21	22			90		
63282	225	12-15	23	28	8,4	8,4	135	8	
63283	250	13-14	25	26			150		● A
63284	270	16-18	29	32					
63285	290	17-19	30	34	10	11,5	250		
63286	320	21-24	38	45	12,5	13,5	470	5	

DIN 1711 | Modelo registrado / Registered model / Modèle enregistré





## CARACTERÍSTICAS / FEATURES / CARACTÉRISTIQUES

Cr-V

A Cromado pulido espejo / Mirror polished chrome plating / Polie chromée / Verchromt geschliffen / Cromate lucide / Cromado polido / Полированный хром

Si no encuentra el artículo que necesita, consúltenos en [info@egamaster.com](mailto:info@egamaster.com) o en [www.egamaster.com](http://www.egamaster.com)  
 If you can't find the item you look for, please ask us in [info@egamaster.com](mailto:info@egamaster.com) or in [www.egamaster.com](http://www.egamaster.com)  
 Si vous ne trouvez pas l'article que vous desirez, consultez-nous a [info@egamaster.com](mailto:info@egamaster.com) ou a [www.egamaster.com](http://www.egamaster.com)

**INCH**

COD.	L (mm)		A (mm)	B (mm)	C (mm)	D (mm)			
<b>63288</b>	185	5/16-3/8	18	21	7,4		60		
<b>63289</b>	200	3/8-7/16	21	22		8,4	90	8	
<b>63290</b>	250	1/2-9/16	25	26			150		●
<b>63291</b>	290	11/16-3/4	30	34	10,0	11,5			A
<b>63292</b>	320	13/16-15/16	38	45	12,5	13,5	250	5	

DIN 1711 | Modelo registrado / Registered model / Modèle enregistré

**CARACTERÍSTICAS / FEATURES / CARACTÉRISTIQUES**

Cr-V

**SET**
**MM**

COD.	PCS.		COD. PCS.	(mm)	
<b>69990</b>	A	6	90056	63280, 63281, 63282, 63283, 63284, 63285	8-9, 10-11, 12-15, 13-14, 16-18, 17-19



A Cromado pulido espejo / Mirror polished chrome plating / Polie chromée / Verchromt geschliffen / Cromate lucide / Cromado polido / Полированный хром

**EXPOSITORES MASTERGEAR / MASTERGEAR DISPLAYS / PRÉSENTOIRS MASTERGEAR / MASTERGEAR AUSSTELLUNGSSTAND / ESPOSITORE MASTERGEAR / EXPOSITORES MASTERGEAR / ДИСПЛЕЙ С КЛЮЧАМИ MASTERGEAR**

■ 186 PCS.

■ MM



COD.	PCS.
<b>55650</b>	A 186

PCS./UN.	COD.	PCS.	
20	62651	8 mm	MASTERGEAR
	62653	10 mm	
	62654	11 mm	
	62655	12 mm	
	62656	13 mm	
	62657	14 mm	
16	62658	15 mm	MASTERGEAR
	62659	16 mm	
14	62660	17 mm	MASTERGEAR
	62662	19 mm	

■ MM

COD.	PCS.
<b>55651</b>	A 186

PCS./UN.	COD.	PCS.	
20	62680	8 mm	MASTERGEAR REV.
	62682	10 mm	
	62683	11 mm	
	62684	12 mm	
	62685	13 mm	
	62686	14 mm	
16	62687	15 mm	MASTERGEAR REV.
	62688	16 mm	
14	62689	17 mm	MASTERGEAR REV.
	62691	19 mm	

■ 180 PCS.

■ MM



COD.	PCS.
<b>65970</b>	A 180

PCS./UN.	COD.	PCS.	
20	62653	10 mm	MASTERGEAR
	62655	12 mm	
	62656	13 mm	
	62660	17 mm	
	62662	19 mm	
	62682	10 mm	
16	62684	12 mm	MASTERGEAR REV.
	62685	13 mm	
14	62689	17 mm	MASTERGEAR REV.
	62691	19 mm	





■ MM

COD.	PCS.
<b>55652</b>	A 186

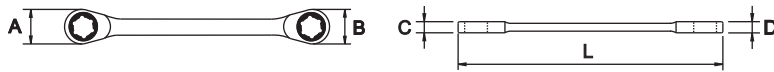
PCS./UN.	COD.	PCS.	
20	61530	8 mm	MASTERGEAR ART. / MASTERGEAR JOINT
	61532	10 mm	
	61533	11 mm	
	61534	12 mm	
	61535	13 mm	
	61536	14 mm	
16	61537	15 mm	MASTERGEAR ART. / MASTERGEAR JOINT
	61538	16 mm	
14	61539	17 mm	MASTERGEAR ART. / MASTERGEAR JOINT
	61541	19 mm	

A Cromado pulido espejo / Mirror polished chrome plating / Polie chromée / Verchromt geschliffen / Cromate lucide / Cromado polido / Полированный хром

**MASTERGEAR E-TORX**



COD.	L (mm)		A (mm)	B (mm)	C (mm)	D (mm)			
62734	120	E6 x E8	18	18	7,4	7,4	49	10	
62735	135	E10 x E12	18	19	7,4	7,4	60	10	
62736	180	E14 x E16	22	25	8,4	8,4	105	8	●
62737	200	E18 x E20	26	29	8,4	10,0	145	10	
62738	220	E22 x E24	30	34	10,0	11,5	210	10	

DIN 1711 | Modelo registrado / Registered model / Modèle enregistré





**CARACTERÍSTICAS / FEATURES / CARACTÉRISTIQUES**

Cr-V

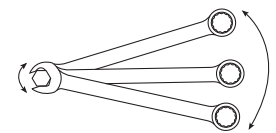
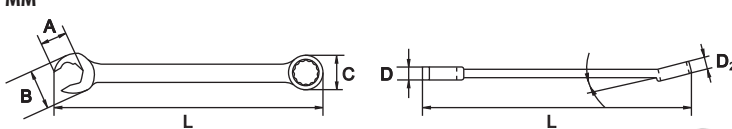
**SET**
**MM**

COD.	PCS.		COD. PCS.	Composición / Composition / Composition
69874	A 5	950	62734, 62735, 62736, 62737, 62738	E6 x E8 - E10 x E12 - E14 x E16 - E18 x E20 - E22 x E24

**RAPID WRENCH**
**LLAVE COMBINADA RÁPIDA / RAPID COMBINATION WRENCH / CLÉ MIXTE RAPIDE / RINGGABELSCHLÜSSEL RAPID / CHIAVE COMBINATA RAPIDA / CHAVE BOCA E LUNETEA DE RETOMA RAPIDA / БЫСТРЫЙ КОМБИНИРОВАННЫЙ КЛЮЧ**
**MM**

 Acción carraca / Ratchet action /  
 Action à cliquet

COD.	L (mm)		A (mm)	B (mm)	C (mm)	D (mm)	D2 (mm)			
62740	140	8	6,5	18	15	5	7	32		
62742	160	10	8,0	22	17	6	8	55		
62743	170	11	9,5	24	19	6	8	70		
62744	175	12	10	26	20	7	9	80		
62745	180	13	11	28	21	7	9	90		
62746	195	14	12	31	23	8	10	110	10	
62747	210	15	12	33	24	8	10	135		●
62748	210	16	14	37	27	9	12	150		
62749	230	17	16	41	30	10	13	170		
62750	230	18	16	41	30	10	13	170		
62751	250	19	16	41	30	10	13	220	5	
62752	250	20	16	41	30	10	13	220	5	

A Cromado pulido espejo / Mirror polished chrome plating / Polie chromée / Verchromt geschliffen / Cromate lucide / Cromado polido / Полированный хром

COD.	L (mm)	AP mm	A (mm)	B (mm)	C (mm)	D (mm)	D2 (mm)	g		
62753	270	21	17	45	32	11	14	290	5	●
62754	300	22		47	34			320		
62755		23	50	34	350					
62756	320	24	55	37	395					
62757	340	26	21	55	37	16	470	A		

DIN 1711

**CARACTERÍSTICAS / FEATURES / CARACTÉRISTIQUES**

Cr-V

Acción carraca / Ratchet action / Action à cliquet

**INCH**

COD.	L (mm)	AP inch	A (mm)	B (mm)	C (mm)	D (mm)	D2 (mm)	g		
62759	160	3/8	8	22	17	6	8	55	10	●
62760	170	7/16	9,5	24	19	8	70			
62761	180	1/2	11	28	21	7	90			
62762	195	9/16	12	31	23	8	110			
62763	210	5/8	14	37	27	9	150			
62764	230	11/16	16	41	30	10	170	5	●	
62765	250	3/4	17	45	32	10	220			
62766	270	13/16	19	50	34	11	290			
62767	300	7/8	21	55	37	11	320			
62768	320	15/16	21	55	37	16	395			
62769	340	1	21	55	37	16	470	A		

DIN 1711

**CARACTERÍSTICAS / FEATURES / CARACTÉRISTIQUES**

Cr-V

Acción carraca / Ratchet action / Action à cliquet

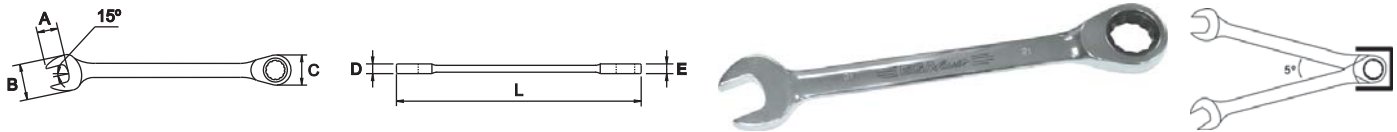
**CLASSICGEAR**
**LLAVE COMBINADA DE CARRACA CLASSICGEAR / CLASSICGEAR COMBINATION RATCHET WRENCH / CLÉ MIXTE À CLIQUET CLASSICGEAR / RATCHEN-RINGGABELSCHLÜSSEL CLASSICGEAR / CHIAVI COMBINATE A CRICCO CLASSICGEAR / CHAVE DE BOCA E LUNETAS DE ROQUETE CLASSICGEAR / CLASSICGEAR КОМБИНИРОВАННЫЙ КЛЮЧ С ТРЕЩЕТКОЙ**
**MM**

COD.	L (mm)	AP mm	A (mm)	B (mm)	C (mm)	D (mm)	E (mm)	g		
63788	114	6	10	17	17	4,2	7	41	10	●
63805		7								
63790	130	8		20	19	4,7	7,7	49		
63791		9								
63792	150	10	12	24	21	5,3	8,2	59		
63793	170	11	14	26	23	5,9	8,5	80		
63794	190	12	15	30	26	6,5	9,4	110		
63795		13								
63796	200	14	17	31	29	7,1	9,7	140		

A Cromado pulido espejo / Mirror polished chrome plating / Polie chromée / Verchromt geschliffen / Cromate lucide / Cromado polido / Полированный хром

COD.	L (mm)	AP mm	A (mm)	B (mm)	C (mm)	D (mm)	E (mm)	g		
63797	200	15	17	31	29	7,1	9,7	140		
63798	220	16	19	37	32	7,7	10,8	195	10	
63799		17	20							
63800	240	18	21	41	35	8,3	11,3	230		
63801		19								
63802	250	21	22	44	39	8,9	11,8	280		●
63803		22	23							
63804	270	24	26	50	44	9,4	12,3	360	8	
63926	290	27	55	48	10,2	13,1	520			
63927	320	30	60	55	11,2	14,1	650			
63928	390	32	65	12,4	15,8	940				

DIN 1711

## INCH

COD.	L (mm)	AP inch	A (mm)	B (mm)	C (mm)	D (mm)	E (mm)	g		
63806	130	5/16	10	20	19	4,7	50			
63807	150	3/8	12	24	21	5,3	60			
63808	170	7/16	14	26	23	5,9	80			
63809	190	1/2	16	30	26	6,5	110		10	
63810	200	9/16	17	31	29	7,1	140			
63811	220	5/8	20	37	32	7,7	195			●
63812		11/16								
63813	240	3/4	21	41	35	8,3	230			A
63814	250	13/16	22	44	39	8,9	280		8	
63815		7/8	23							
63816	290	1	31	50	44	10,2	440			13,1

DIN 1711

## SET

## MM

COD.	PCS.		COD. PCS.	(mm)
68230	6	90056	63790, 63792, 63794, 63795, 63799, 63801	8, 10, 12, 13, 17, 19
68231	A	90083	63790, 63791, 63792, 63793, 63794, 63795, 63796, 63797, 63798, 63799, 63800, 63801	8, 9, 10, 11, 12, 13, 14, 15, 16, 17, 18, 19



## INCH

COD.	PCS.		COD. PCS.	(inch)
68232	6	90056	63806, 63807, 63808, 63809, 63812, 63813	5/16 - 3/8 - 7/16 - 1/2 - 11/16 - 3/4
68233	A	90054	63807, 63808, 63809, 63810, 63811, 63812, 63813, 63814, 63815, 63816	3/8 - 7/16 - 1/2 - 9/16 - 5/8 - 11/16 - 3/4 - 13/16 - 7/8 - 1

**CLASSICGEAR ARTICULADA / CLASSICGEAR JOINT / CLASSICGEAR ARTICULEE / RATSCHENRINGGABELSCHLUSSEL MIT VERSTELLBAREM KOPF / CLASSICGEAR SNODATA / CLASSICGEAR ARTICULADA / CLASSICGEAR ШАРНИР**
**LLAVE COMBINADA DE CARRACA ARTICULADA CLASSICGEAR / CLASSICGEAR JOINT COMBINATION RATCHET WRENCH / CLÉ MIXTE À CLIQUET ARTICULÉE CLASSICGEAR / RATSCHEN-RINGGABELSCHLÜSSEL MIT VERSTELLBAREM KOPF / CHIAVI COMBINATE A CRICCO ARTICOLATA CLASSICGEAR / CHAVE DE BOCA E LUNETA DE ROQUETE ARTICULADO CLASSICGEAR / CLASSICGEAR КОМБИНИРОВАННЫЙ КЛЮЧ С ПОВРОТНОЙ ТРЕЩЕТКОЙ**

MM

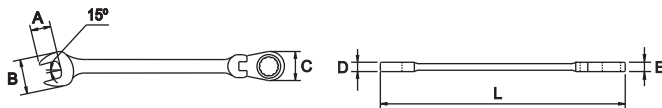

COD.	L (mm)	AP <sup>mm</sup>	A (mm)	B (mm)	C (mm)	D (mm)	E (mm)	g								
63833	124	6	10	17	17	4,2	7	50	10							
63817		7														
63818	140	8	20	19	4,7	7,7	55	8								
63819		9														
63820	160	10	12	24	21	5,3	8,2					70				
63821	175	11	14	26	23	5,9	8,5					95				
63822	190	12	15	30	26	6,5	9,4					130				
63823		13														
63824	210	14	17	31	29	7,1	9,7					170				
63825		15														
63826	230	16	19	37	32	7,7	10,8		220							
63827		17														
63828	250	18	21	41	35	8,3	11,3	260								
63829		19														
63830	260	21	22	44	39	8,9	11,8	310								
63831		22														
63832	270	24	50	44	9,4	12,3	390	8								
63930	290	27	26	55	48	10,2	13,1						540			
63931	320	30	32	60	55	11,2	14,1						670			
63932	390	32	36	65		12,4	15,8						1040			

DIN 1711

INCH

COD.	L (mm)	AP <sup>inch</sup>	A (mm)	B (mm)	C (mm)	D (mm)	E (mm)	g				
63834	140	5/16	10	20	19	4,7	7,7	50	10			
63835	155	3/8	12	24	21	5,3	8,2	70				
63836	175	7/16	14	26	23	5,9	8,5	95				
63837	195	1/2	16	30	26	6,5	9,4	130				
63838	210	9/16	17	31	29	7,1	9,7	170				
63839	230	5/8	19	37	32	7,7	10,8	220				
63840		11/16										
63841	250	3/4	21	41	35	8,3	11,3	260				
63842	260	13/16	22	44	39	8,9	11,8	310				
63843		7/8										
63844	290	1	31	50	44	10,2	13,1	390	8			

DIN 1711

A Cromado pulido espejo / Mirror polished chrome plating / Polie chromée / Verchromt geschliffen / Cromate lucide / Cromado polido / Полированный хром

## ■ SET

## ■ MM

COD.	PCS.		COD. PCS.	(mm)
<b>68234</b>	6	90056	63818, 63820, 63822, 63823, 63827, 63829	8, 10, 12, 13, 17, 19
<b>68235</b>	A 12	90083	63818, 63819, 63820, 63821, 63822, 63823, 63824, 63825, 63826, 63828, 63829, 63827	8, 9, 10, 11, 12, 13, 14, 15, 16, 17, 18, 19



## ■ INCH

COD.	PCS.		COD. PCS.	(inch)
<b>68236</b>	6	90056	63834, 63835, 63836, 63837, 63840, 63841	5/16 - 3/8 - 7/16 - 1/2 - 11/16 - 3/4
<b>68237</b>	A 10	90054	63835, 63836, 63837, 63838, 63839, 63840, 63841, 63842, 63843, 63844	3/8 - 7/16 - 1/2 - 9/16 - 5/8 - 11/16 - 3/4 - 13/16 - 7/8 - 1

# EGA Master

## ART IN INNOVATION



EXPOSITORES CLASSICGEAR / CLASSICGEAR DISPLAYS / PRÉSENTOIRS CLASSICGEAR / CLASSICGEAR AUSSTELLUNGSSTAND / ESPOSITORE CLASSICGEAR /  
EXPOSITORES CLASSICGEAR / ДИСПЛЕЙ С ГАЕЧНЫМИ КЛЮЧАМИ CLASSICGEAR

■ 186 PCS.

■ MM



COD.	PCS.
<b>55653</b>	A 186

PCS./UN.	COD.	PCS.	
20	63790	8 mm	CLASSICGEAR
	63792	10 mm	
	63793	11 mm	
	63794	12 mm	
	63795	13 mm	
	63796	14 mm	
16	63797	15 mm	
	63798	16 mm	
14	63799	17 mm	
	63801	19 mm	

■ 180 PCS.

■ MM



COD.	PCS.
<b>65971</b>	A 180

PCS./UN.	COD.	PCS.	
20	63792	10 mm	CLASSICGEAR
	63794	12 mm	
	63795	13 mm	
16	63799	17 mm	
	63801	19 mm	
20	63820	10 mm	CLASSICGEAR ART. / CLASSICGEAR JOINT
	63822	12 mm	
	63823	13 mm	
16	63827	17 mm	
	63829	19 mm	

■ MM

COD.	PCS.
<b>55654</b>	A 186

PCS./UN.	COD.	PCS.	
20	63818	8 mm	CLASSICGEAR ART. / CLASSICGEAR JOINT
	63820	10 mm	
	63821	11 mm	
	63822	12 mm	
	63823	13 mm	
	63824	14 mm	
16	63825	15 mm	
	63826	16 mm	
14	63827	17 mm	
	63829	19 mm	

A Cromado pulido espejo / Mirror polished chrome plating / Polie chromée / Verchromt geschliffen / Cromate lucide / Cromado polido / Полированный хром

Si no encuentra el artículo que necesita, consúltenos en [info@egamaster.com](mailto:info@egamaster.com) o en [www.egamaster.com](http://www.egamaster.com)  
If you can't find the item you look for, please ask us in [info@egamaster.com](mailto:info@egamaster.com) or in [www.egamaster.com](http://www.egamaster.com)  
Si vous ne trouvez pas l'article que vous desirez, consultez-nous a [info@egamaster.com](mailto:info@egamaster.com) ou a [www.egamaster.com](http://www.egamaster.com)

■ **LLAVES FIJAS / OPEN-END WRENCHES / CLÉS À FOURCHE / GABELSCHLÜSSEL / CHIAVI FISSE / CHAVES DUAS BOCAS / РОЖКОВЫЕ КЛЮЧИ**

■ MM

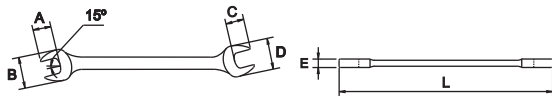

COD.	COD.	L (mm)	AF mm	A (mm)	B (mm)	C (mm)	D (mm)	E (mm)	g		
-	67963	100	4-4,5	9,0	13	9,0	14	3,4	10		
-	67965		4-5								
-	67967		5-5,5								
-	67907	125	5,5-7	9,5	16	10	18	3,9	20		
61601	61701		6-7								
-	62928		7-8								
61602	61702	140	8-9	10	19	21	21	21	38		
-	67908		8-10								
61603	61703		10-11								
-	62629	155	10-13	11	26	11	24	5,5	55		
-	67909		11-13								
61604	61704		12-13								
-	67910	175	12-14	12	28	28	28	7,0	70		
-	67911		13-14								
-	67912		13-15								
-	67913	190	13-16	14	30	15	33	6,0	100		
61605	61705		14-15								
-	67914		13-17								
-	62930	210	14-17	14	33	16	36	7,0	110		
61606	61706		16-17								
-	67915		16-18								
61614	61700	220	17-19	18	39	18	41	8,0	160		
61607	61707		18-19								
-	67916		18-21								
-	62931	230	19-22	19	43	22	47	200			
61608	61708		20-22								
61609	61709		21-23								
-	63961	240	21-24	23	47	23	50	250			
-	67917		22-24								
61610	61710		24-26								
61651	61652	270	24-27	27	50	30	55	330			
61611	61711		25-28								
61612	61712		27-29								
-	67918	290	27-30	30	55	34	65	10	430		
-	67919		27-32								
61613	61713		30-32								
-	67970	320	36-41	36	80	42	70	12	850		
-	67920		38-42								
-	67972		41-46								
-	67974	360	38-42	42	85	42	75	12	900		
-		370	41-46	42	90	47	80	13	1200		
-		400	46-50	47	100	50	90	14	1500		

DIN 3110

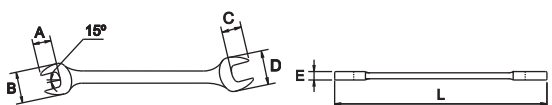

■ INCH



COD.	L (mm)	AF inch	A (mm)	B (mm)	C (mm)	D (mm)	E (mm)	g			
60315	105	3/16-7/32	4	14	5	15	15	10			

A Cromado pulido espejo / Mirror polished chrome plating / Polie chromée / Verchromt geschliffen / Cromate lucide / Cromado polido / Полированный хром

B Cromado aeroespacial / Aerospaceal chrome plating / Chromée aérospatiale / Verchromt aerospaceal / Cromate satinato / Cromado fosco aeroespacial / Матовый хром

COD.	L (mm)	AF <sup>inch</sup> mm	A (mm)	B (mm)	C (mm)	D (mm)	g			E (mm)
60300	120	1/4-5/16	8,0	14	9,0	17	22			3,6
60301	140	5/16-3/8	10	20						3,8
67941		5/16-11/32	11		12	22	38			
67931	145	11/32-13/32	12							4
60302	160	3/8-7/16		22	13	24	50	10		
67942		7/16-1/2	13	26			55			
60303	175	1/2-9/16	14	27	15	28	60			5,5
60304	190	9/16-5/8	17	30	17	33	70			
60305	200	19/32-11/16			19	38	85			
60306		5/8-11/16	18	35	18		115			6,0
67943	210	5/8-3/4			20	36	125			7,0
60307		11/16-3/4	19	38		40	130			6,0
60308	220	3/4-25/32		39	21		160			6,5
67934		3/4-13/16	21			41	190		● A	
60309	230	3/4-7/8		44	24	48	200			7,0
60310		13/16-7/8		45		50	250			7,5
67944	250	7/8-15/16	25	47	28		260			
60311	260	15/16-1		50			330	5		
67945		15/16-1.1/8			29		370			8,0
67939		1-1.1/16	26		28	60	390			
60312	280	1-1.1/8		55	30		420			
60313		1.1/16-1.1/8	28		31		430			8,5
60314	320	1.1/16-1.1/4		60			500			
67940		1.1/8-1.1/4	35		36	65	550			10
67961		1.3/16-1.5/16		70						
67968	320	1.3/8-1.1/2				70	650			
67946		1.7/16-1.5/8	36		42	80	850	1		12

DIN 3110

**CARACTERÍSTICAS / FEATURES / CARACTÉRISTIQUES**

Cr-V

■ SET

■ MM

COD.	PCS.		COD. PCS.	(mm)
69244	6	90052	61601, 61602, 61603, 61604, 61605, 61606	6-7, 8-9, 10-11, 12-13, 14-15, 16-17
69245	8	90053	61601, 61602, 61603, 61604, 61605, 61606, 61607, 61608	6-7, 8-9, 10-11, 12-13, 14-15, 16-17, 18-19, 20-22
69246	A 10	90054	61601, 61602, 61602, 61604, 61605, 61606, 61607, 61608, 61609, 61610	6-7, 8-9, 10-11, 12-13, 14-15, 16-17, 18-19, 20-22, 21-23, 24-26
69247			61601, 61602, 61603, 61604, 61605, 61606, 61607, 61608, 61609, 61610, 61611, 61613	6-7, 8-9, 10-11, 12-13, 14-15, 16-17, 18-19, 20-22, 21-23, 24-26, 25-28, 30-32
69794	12	90055	61601, 61602, 61603, 61604, 61605, 61606, 61607, 61608, 61609, 61651, 61611, 61613	6-7, 8-9, 10-11, 12-13, 14-15, 16-17, 18-19, 20-22, 21-23, 24-27, 25-28, 30-32

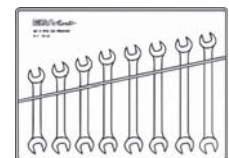

**A** Cromado pulido espejo / Mirror polished chrome plating / Polie chromée / Verchromt geschliffen / Cromate lucide / Cromado polido / Полированный хром

Si no encuentra el artículo que necesita, consúltenos en [info@egamaster.com](mailto:info@egamaster.com) o en [www.egamaster.com](http://www.egamaster.com)  
 If you can't find the item you look for, please ask us in [info@egamaster.com](mailto:info@egamaster.com) or in [www.egamaster.com](http://www.egamaster.com)  
 Si vous ne trouvez pas l'article que vous desirez, consultez-nous a [info@egamaster.com](mailto:info@egamaster.com) ou a [www.egamaster.com](http://www.egamaster.com)

## MM

COD.	PCS.		COD. PCS.	(mm)
69248	6	90052	61701, 61702, 61703, 61704, 61705, 61706	6-7, 8-9, 10-11, 12-13, 14-15, 16-17
69249	8	90053	61701, 61702, 61703, 61704, 61705, 61706, 61707, 61708	6-7, 8-9, 10-11, 12-13, 14-15, 16-17, 18-19, 20-22
69250	10	90054	61701, 61702, 61703, 61704, 61705, 61706, 61707, 61708, 61709, 61710	6-7, 8-9, 10-11, 12-13, 14-15, 16-17, 18-19, 20-22, 21-23, 24-26
69251	B			6-7, 8-9, 10-11, 12-13, 14-15, 16-17, 18-19, 20-22, 21-23, 24-26, 25-28, 30-32 mm
69795	12	90055	61701, 61702, 61703, 61704, 61705, 61706, 61707, 61708, 61709, 61652, 61711, 61713	6-7, 8-9, 10-11, 12-13, 14-15, 16-17, 18-19, 20-22, 21-23, 24-27, 25-28, 30-32

## INCH

COD.	PCS.		COD. PCS.	(inch)	
69310	6	90052	60302, 60303, 60304, 60305, 60306, 60310	3/8-7/16, 1/2-9/16, 9/16-5/8, 19/32-11/16, 5/8-11/16, 13/16-7/8	
69311	8	90053	60302, 60303, 60304, 60305, 60306, 60310, 60309, 60311	3/8-7/16, 1/2-9/16, 9/16-5/8, 19/32-11/16, 5/8-11/16, 3/4-7/8, 13/16-7/8, 15/16-1	
69312	A	10	90054	60300, 60301, 60302, 60303, 60304, 60306, 60310, 60311, 60312, 60314	1/4-5/16, 5/16-3/8, 3/8-7/16, 1/2-9/16, 9/16-5/8, 5/8-11/16, 13/16-7/8, 15/16-1, 1-1.1/8, 1.1/16-1.1/4
69313	12	90055	60300, 60301, 60302, 60303, 60304, 60306, 60310, 60311, 60312, 60313, 60314, 60309	1/4-5/16, 5/16-3/8, 3/8-7/16, 1/2-9/16, 9/16-5/8, 5/8-11/16, 3/4-7/8, 13/16-7/8, 15/16-1, 1-1.1/8, 1.1/16-1.1/8, 1.1/16-1.1/4	

## MM

COD.	PCS.	COD. PCS.	(mm)	
68451	6	61601, 61602, 61603, 61604, 61605, 61606	6-7, 8-9, 10-11, 12-13, 14-15, 16-17	
69444	8	61601, 61602, 61603, 61604, 61605, 61601, 61607, 61608	6-7, 8-9, 10-11, 12-13, 14-15, 16-17, 18-19, 20-22	
68452	A	10	61601, 61602, 61603, 61604, 61605, 61606, 61607, 61608, 61609, 61610	6-7, 8-9, 10-11, 12-13, 14-15, 16-17, 18-19, 20-22, 21-23, 24-26
69445	12	61601, 61602, 61603, 61604, 61605, 61606, 61607, 61608, 61609, 61610, 61611, 61613	6-7, 8-9, 10-11, 12-13, 14-15, 16-17, 18-19, 20-22, 21-23, 24-26, 25-28, 30-32	

## MM

COD.	PCS.	COD. PCS.	(mm)	
68453	6	61701, 61702, 61703, 61704, 61705, 61706	6-7, 8-9, 10-11, 12-13, 14-15, 16-17	
69446	8	61701, 61702, 61703, 61704, 61705, 61706, 61707, 61708	6-7, 8-9, 10-11, 12-13, 14-15, 16-17, 18-19, 20-22	
68454	B	10	61701, 61702, 61703, 61704, 61705, 61706, 61707, 61708, 61709, 61710	6-7, 8-9, 10-11, 12-13, 14-15, 16-17, 18-19, 20-22, 21-23, 24-26
69447	12	61701, 61702, 61703, 61704, 61705, 61706, 61707, 61708, 61709, 61710, 61711, 61713	6-7, 8-9, 10-11, 12-13, 14-15, 16-17, 18-19, 20-22, 21-23, 24-26, 25-28, 30-32	

## INCH

COD.	PCS.	COD. PCS.	(inch)	
68467	6	60302, 60303, 60304, 60305, 60306, 60310	3/8 - 7/16 - 1/2 - 9/16 - 9/16 - 5/8 - 19/32 - 11/16 - 5/8 - 11/16 - 13/16 - 7/8	
69452	8	60301, 60302, 60303, 60304, 60305, 60306, 60308, 60310	5/16 - 3/8 - 3/8 - 7/16 - 1/2 - 9/16 - 9/16 - 5/8 - 19/32 - 11/16 - 5/8 - 11/16 - 3/4 - 7/8 - 13/16 - 7/8	
68468	A	10	60300, 60301, 60302, 60303, 60304, 60306, 60310, 60311, 60312, 60314	1/4 - 5/16 - 5/16 - 3/8 - 3/8 - 7/16 - 1/2 - 9/16 - 9/16 - 5/8 - 5/8 - 11/16 - 13/16 - 7/8 - 15/16 - 1 - 1 - 1.1/8 - 1.1/16 - 1.1/4
69453	12	60300, 60301, 60302, 60303, 60304, 60306, 60309, 60310, 60311, 60312, 60313, 60314	1/4 - 5/16 - 5/16 - 3/8 - 3/8 - 7/16 - 1/2 - 9/16 - 9/16 - 5/8 - 5/8 - 11/16 - 3/4 - 7/8 - 13/16 - 7/8 - 15/16 - 1 - 1 - 1.1/8 - 1.1/16 - 1.1/8 - 1.1/16 - 1.1/4	

A Cromado pulido espejo / Mirror polished chrome plating / Polie chromée / Verchromt geschliffen / Cromate lucide / Cromado polido / Полированный хром

B Cromado aeroespacial / Aerospaceal chrome plating / Chromée aérospatiale / Verchromt aerospaceal / Cromate satinata / Cromado fosco aeroespacial / Матовый хром

**LLAVES COMBINADAS / COMBINATION WRENCHES / CLÉS MIXTES / RINGGABELSCHLÜSSEL / CHIAVI COMBINATE / CHAVES BOCA E LUNETA / КОМБИНИРОВАННЫЕ КЛЮЧИ**

MM

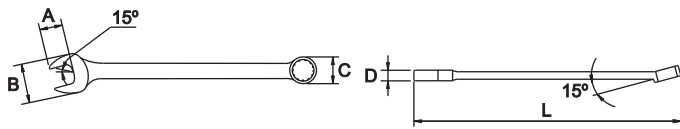

COD.	COD.	L (mm)	AF mm	A (mm)	B (mm)	C (mm)	D (mm)	g		
-	63965	70	3,2					8,0		
-	63966	65	4	3,7				9,0		
-	63967	80	5	4,5			3,0			
-	67881		5,5					16		
61625	61725	100	6	7,0				3,3		
61626	61726	110	7		16	12		3,6		
61627	61727	120	8		18	13		4,5		
61628	61728	130	9	10	19	15		5,0		
61629	61729	140	10	11	21	17		5,5		
61630	61730		11	12	23	18		45		
61631	61731	160	12	14	25	19		52	10	
61632	61732		13	15	27	20		70		
61633	61733	180	14		29	21	6,5	75		
61634	61734	190	15	16	32	23		90		
61635	61735	200	16		33	24				
61636	61736	210	17	18	35	26	7,5	110		
61637	61737		18		38			135		
61638	61738	230	19	21	39	29		160		
61639	61739	240	20	23	41	30		180		
61640	61740	250	21	24	46	31	8,0	210		
61641	61741	260	22	25	48	33		220		
61642	61742		23		48			260		
61643	61743	280	24	26	49	35		280		
61644	61744		25		50	36		290		
61645	61745	300	26	29	50	36	9,0	360		
61646	61746	330	27		55	37		420		
61647	61747		28	32	60	41	10	450	5	
61648	61748	340	29		60	42		500		
61649	61749		30	33	65	43	11	550		
61650	61750	350	32			47				
-	57062	360	33	34	70	49		600		
-	60951	385	34				14			
-	57063	380	35	35	75	52		650		
-	60952	405	36		80	55	15	900		
-	57064	400	37	36	75	60	14	800		
-	60953	410	38	38	83	58	16	1000	1	
-	67895	450	40	41	88	63	17	1300		
-	60954		41							
-	57065	440	42	42	85	60	16	1200		

A Cromado pulido espejo / Mirror polished chrome plating / Polie chromée / Verchromt geschliffen / Cromate lucide / Cromado polido / Полированный хром

B Cromado aeroespacial / Aerospaceal chrome plating / Chromée aérospatiale / Verchromt aeroespaciale / Cromate satinata / Cromado fosco aeroespacial / Матовый хром

COD.	COD.	L (mm)	AP mm	A (mm)	B (mm)	C (mm)	D (mm)	g		
-	<b>57066</b>	500	44	46	90	65	16	1500		
-	<b>60955</b>	530	46	48	100	75	18	1800		
-	<b>57067</b>	535	48	50	105	76	19	2200		
-	<b>60956</b>	600	50	50	105	80	19	2300	1	-
-	<b>67882</b>	600	55	60	105	80	19	3000		
-	<b>67883</b>	650	60	65	115	90	21	3550		
-	<b>67884</b>	700	65	70	125	95	23	3800		

DIN 3113

INCH

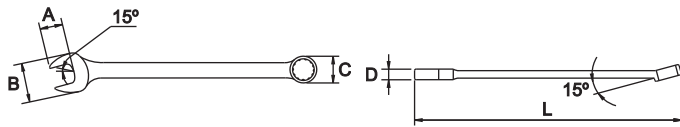

COD.	L (mm)	AP inch	A (mm)	B (mm)	C (mm)	D (mm)	g			
<b>67953</b>	95	3/16	5,0			3,0	8,0			
<b>67954</b>	100	7/32		14	9,0					
<b>61653</b>	100	15/64	6,5			3,8	16			
<b>60340</b>	110	1/4								
<b>67885</b>	110	9/32	7	20	12,5	4	17			
<b>60341</b>	120	5/16	9,0	17	12	4,5	25			
<b>67878</b>	130	11/32	10	19	15		28			
<b>60342</b>	140	3/8	11		16	5,5	38			
<b>60343</b>	170	7/16	14	26	20	6,0	45	10		
<b>60344</b>	180	1/2	15			6,5	70			
<b>60345</b>	180	9/16	16	29	21	7,0	75			
<b>60346</b>	190	19/32	16	31	23		90			
<b>60347</b>	200	5/8	17	32	25	7,5				
<b>60348</b>	220	11/16	19				130			
<b>60349</b>	220	3/4	20	37	28	8,0	160			
<b>60350</b>	240	25/32	22	41	31		180			
<b>60351</b>	250	13/16	23	43	32		210			
<b>60352</b>	280	7/8	24	48	35	8,5	220			
<b>60353</b>	290	15/16	26	50	36		280			
<b>60354</b>	290	1	27		38	9,0	300			
<b>60355</b>	310	1.1/16	29	55	39		420	5		A
<b>60356</b>	360	1.1/8			42	10	450			
<b>60357</b>	360	1.3/16	33	60	43		500			
<b>60358</b>	390	1.1/4	34		45	11				
<b>60957</b>	380	1.5/16		65	51	13	600			
<b>60958</b>	405	1.3/8	36	80	55	15	900			
<b>60961</b>	405	1.7/16								
<b>60959</b>	407	1.1/2	38	83	58	16	1000			
<b>67840</b>	410	1.9/16	39	80	60					
<b>60962</b>	446	1.5/8		88	63					
<b>67841</b>	450	1.11/16	41	90	65	17	1300			
<b>60897</b>		1.3/4								
<b>60898</b>	500	1.13/16	46	96	70	18	1800	1		
<b>60899</b>		1.7/8								
<b>67842</b>	550	1.15/16	50		75	19	2300			
<b>60960</b>	535	2			76					
<b>60905</b>	600	2.3/16"		105			2200			
<b>61099</b>	600	2.1/4"	55		80	20	2800			
<b>67955</b>	650	2.3/8	60	115	90	21	2900			
<b>67956</b>	700	2.1/2	65	125	95	23	2300			

DIN 3113

A Cromado pulido espejo / Mirror polished chrome plating / Polie chromée / Verchromt geschliffen / Cromate lucide / Cromado polido / Полированный хром

B Cromado aeroespacial / Aerospaceal chrome plating / Chromée aérospatiale / Verchromt aerospaceal / Cromate satinato / Cromado fosco aeroespacial / Матовый хром

## CARACTERÍSTICAS / FEATURES / CARACTÉRISTIQUES

Cr-V

■ SET

■ MM

COD.	PCS.		COD. PCS.	(mm)
69258	6	90080	61627, 61629, 61631, 61633, 61636, 61638	8, 10, 12, 14, 17, 19
69259	8	90081	61627, 61629, 61631, 61632, 61633, 61636, 61638, 61641	8, 10, 12, 13, 14, 17, 19, 22
69273	10	90082	61627, 61628, 61629, 61630, 61631, 61632, 61633, 61636, 61638, 61641	8, 9, 10, 11, 12, 13, 14, 17, 19, 22
69274	12	90083	61625, 61626, 61627, 61628, 61629, 61630, 61631, 61632, 61633, 61634, 61635, 61636	6, 7, 8, 9, 10, 11, 12, 13, 14, 15, 16, 17
68513	13	90060	61625, 61627, 61629, 61630, 61632, 61633, 61634, 61636, 61638, 61639, 61641, 61643, 61644	6, 8, 10, 11, 13, 14, 15, 17, 19, 20, 22, 24, 25
69261	14	90063	61629, 61630, 61631, 61633, 61635, 61636, 61638, 61639, 61641, 61643, 61644, 61646, 61647, 61650	10, 11, 12, 14, 16, 17, 19, 20, 22, 24, 25, 27, 28, 32
68521	A 15	90061	61629, 61630, 61632, 61633, 61634, 61636, 61638, 61639, 61641, 61643, 61644, 61646, 61648, 61649, 61650	10, 11, 13, 14, 15, 17, 19, 20, 22, 24, 25, 27, 29, 30, 32
69275	17	90064	61625, 61626, 61627, 61628, 61629, 61630, 61631, 61632, 61633, 61634, 61635, 61636, 61637, 61638, 61639, 61640, 61641	6, 7, 8, 9, 10, 11, 12, 13, 14, 15, 16, 17, 18, 19, 20, 21, 22
69552	17	90064	61626, 61627, 61628, 61621, 61630, 61631, 61632, 61633, 61634, 61635, 61636, 61637, 61638, 61639, 61640, 61641, 61643	7, 8, 9, 10, 11, 12, 13, 14, 15, 16, 17, 18, 19, 20, 21, 22, 24
69276	26	90065	61625, 61626, 61627, 61628, 61629, 61630, 61631, 61632, 61633, 61634, 61635, 61636, 61637, 61638, 61639, 61640, 61641, 61642, 61643, 61644, 61645, 61646, 61647, 61648, 61649, 61650	6, 7, 8, 9, 10, 11, 12, 13, 14, 15, 16, 17, 18, 19, 20, 21, 22, 23, 24, 25, 26, 27, 28, 29, 30, 32

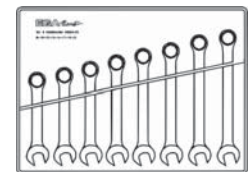
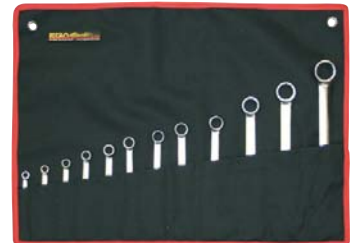

■ MM

COD.	PCS.		COD. PCS.	(mm)
69262	6	90080	61727, 61729, 61731, 61733, 61736, 61738	8, 10, 12, 14, 17, 19
69263	8	90081	61727, 61729, 61731, 61732, 61733, 61736, 61738, 61741	8, 10, 12, 13, 14, 17, 19, 22
69277	10	90082	61727, 61728, 61729, 61730, 61731, 61732, 61733, 61736, 61738, 61741	8, 9, 10, 11, 12, 13, 14, 17, 19, 22
69278	12	90083	61725, 61726, 61727, 61728, 61729, 61730, 61731, 61732, 61733, 61734, 61735, 61736	6, 7, 8, 9, 10, 11, 12, 13, 14, 15, 16, 17
68514	13	90060	61725, 61727, 61729, 61730, 61732, 61733, 61734, 61736, 61738, 61739, 61741, 61743, 61744	6, 8, 10, 11, 13, 14, 15, 17, 19, 20, 22, 24, 25
69265	14	90063	61729, 61730, 61731, 61733, 61735, 61736, 61738, 61739, 61741, 61743, 61744, 61746, 61747, 61750	10, 11, 12, 14, 16, 17, 19, 20, 22, 24, 25, 27, 28, 32
69796	B 14	90063	61729, 61730, 61731, 61733, 61735, 61736, 61738, 61739, 61741, 61743, 61744, 61746, 61749, 61750	10, 11, 12, 14, 16, 17, 19, 20, 22, 24, 25, 27, 30, 32
68522	15	90061	61729, 61730, 61732, 61733, 61734, 61736, 61738, 61739, 61741, 61743, 61746, 61748, 61749, 61750, 61744	10, 11, 13, 14, 15, 17, 19, 20, 22, 24, 25, 27, 29, 30, 32
69279	17	90064	61725, 61726, 61727, 61728, 61729, 61730, 61731, 61732, 61733, 61734, 61735, 61736, 61737, 61738, 61739, 61740, 61741	6, 7, 8, 9, 10, 11, 12, 13, 14, 15, 16, 17, 18, 19, 20, 21, 22
69556	17	90064	61726, 61727, 61728, 61729, 61730, 61731, 61732, 61733, 61734, 61735, 61736, 61737, 61738, 61739, 61740, 61741, 61743	7, 8, 9, 10, 11, 12, 13, 14, 15, 16, 17, 18, 19, 20, 21, 22, 24
69280	26	90065	61725, 61726, 61727, 61728, 61729, 61730, 61731, 61732, 61733, 61734, 61735, 61736, 61737, 61738, 61739, 61740, 61741, 61742, 61743, 61744, 61745, 61746, 61747, 61748, 61749, 61750	6, 7, 8, 9, 10, 11, 12, 13, 14, 15, 16, 17, 18, 19, 20, 21, 22, 23, 24, 25, 26, 27, 28, 29, 30, 32

A Cromado pulido espejo / Mirror polished chrome plating / Polie chromée / Verchromt geschliffen / Cromate lucide / Cromado pulido / Полированный хром

B Cromado aeroespacial / Aerospaceal chrome plating / Chromée aérospatiale / Verchromt aeroespaciaal / Cromate satinata / Cromado fosco aeroespacial / Матовый хром

## INCH

COD.	PCS.		COD. PCS.	(inch)
69330	6	90080	60342, 60343, 60344, 60345, 60347, 60349	3/8, 7/16, 1/2, 9/16, 5/8, 3/4
69331	8	90081	60341, 60342, 60343, 60344, 60345, 60347, 60348, 60349	5/16, 3/8, 7/16, 1/2, 9/16, 5/8, 11/16, 3/4
69332	10	90082	60342, 60343, 60344, 60345, 60347, 60348, 60349, 60351, 60352, 60354	3/8, 7/16, 1/2, 9/16, 5/8, 11/16, 3/4, 13/16, 7/8, 1
69333	12	90083	60341, 60342, 60343, 60344, 60345, 60347, 60348, 60349, 60351, 60352, 60353, 60354	5/16, 3/8, 7/16, 1/2, 9/16, 5/8, 11/16, 3/4, 13/16, 7/8, 15/16, 1
68502	A 13	90060	60340, 60341, 60342, 60343, 60344, 60345, 60347, 60348, 60349, 60351, 60352, 60353, 60354	1/4, 5/16, 3/8, 7/16, 1/2, 9/16, 5/8, 11/16, 3/4, 13/16, 7/8, 15/16, 1
69334	14	90063	60342, 60343, 60344, 60345, 60347, 60348, 60349, 60351, 60352, 60353, 60354, 60355, 60356, 60358	3/8, 7/16, 1/2, 9/16, 5/8, 11/16, 3/4, 13/16, 7/8, 15/16, 1, 1.1/16, 1.1/8, 1.1/4
68505	15	90061	60342, 60343, 60344, 60345, 60347, 60348, 60349, 60351, 60352, 60353, 60354, 60355, 60356, 60357, 60358	3/8, 7/16, 1/2, 9/16, 5/8, 11/16, 3/4, 13/16, 7/8, 15/16, 1, 1.1/16, 1.1/8, 1.3/16, 1.1/4
69335	17	90064	60340, 60341, 60342, 60343, 60344, 60345, 60346, 60347, 60348, 60349, 60350, 60351, 60352, 60353, 60354, 60355, 60356	1/4, 5/16, 3/8, 7/16, 1/2, 9/16, 19/32, 5/8, 11/16, 3/4, 25/32, 13/16, 7/8, 15/16, 1, 1.1/16, 1.1/8

## MM

COD.	PCS.	COD. PCS.	(mm)
68455	A 6	61627, 61629, 61631, 61633, 61636, 61638	8, 10, 12, 14, 17, 19
69448	8	61627, 61628, 61629, 61630, 61631, 61633, 61636, 61638	8, 9, 10, 11, 12, 14, 17, 19
68458	B 10	61627, 61628, 61629, 61630, 61631, 61632, 61633, 61636, 61638, 61641	8, 9, 10, 11, 12, 13, 14, 17, 19, 22
69449	A 12	61625, 61626, 61627, 61628, 61629, 61630, 61631, 61632, 61633, 61634, 61635, 61636	6, 7, 8, 9, 10, 11, 12, 13, 14, 15, 16, 17



## MM

COD.	PCS.	COD. PCS.	(mm)
68457	6	61727, 61729, 61731, 61733, 61736, 61738	8, 10, 12, 14, 17, 19
69450	8	61727, 61728, 61729, 61730, 61731, 61733, 61736, 61738	8, 9, 10, 11, 12, 14, 17, 19
68456	B 10	61727, 61728, 61729, 61730, 61731, 61732, 61733, 61736, 61738, 61741	8, 9, 10, 11, 12, 13, 14, 17, 19, 22
69451	12	61725, 61726, 61727, 61728, 61729, 61730, 61731, 61732, 61733, 61734, 61735, 61736	6, 7, 8, 9, 10, 11, 12, 13, 14, 15, 16, 17

## INCH

COD.	PCS.	COD. PCS.	(inch)
68469	6	60342, 60343, 60344, 60345, 60347, 60349	3/8 - 7/16 - 1/2 - 9/16 - 5/8 - 3/4
69454	8	60341, 60342, 60343, 60344, 60345, 60347, 60348, 60349	5/16 - 3/8 - 7/16 - 1/2 - 9/16 - 5/8 - 11/16 - 3/4
68470	A 10	60342, 60343, 60344, 60345, 60347, 60348, 60349, 60351, 60352, 60354	3/8 - 7/16 - 1/2 - 9/16 - 5/8 - 11/16 - 3/4 - 13/16 - 7/8 - 1
69455	12	60341, 60342, 60343, 60344, 60345, 60348, 60347, 60349, 60351, 60352, 60353, 60354	5/16 - 3/8 - 7/16 - 1/2 - 9/16 - 5/8 - 11/16 - 3/4 - 13/16 - 7/8 - 15/16 - 1

A Cromado pulido espejo / Mirror polished chrome plating / Polie chromée / Verchromt geschliffen / Cromate lucide / Cromado polido / Полированный хром

B Cromado aeroespacial / Aerospaceal chrome plating / Chromée aérospatiale / Verchromt aerospaceal / Cromate satinate / Cromado fosco aeroespacial / Матовый хром



■ EXPOSITORES / DISPLAYS / PRESENTOIRS / DISPLAY / ESPOSITORI / DISPLAY STAND / СТЕНДЫ

■ 165 PCS.

■ MM



COD.	PCS.
<b>55655</b>	A
PCS./UN.	COD. PCS.
	61627 8 mm
	61629 10 mm
20	61630 11 mm
	61631 12 mm
	61632 13 mm
15	61633 14 mm
14	61634 15 mm
13	61635 16 mm
12	61636 17 mm
11	61638 19 mm

■ 162 PCS.

■ INCH



COD.	PCS.
<b>55657</b>	A
PCS./UN.	COD. PCS.
	60342 3/8"
20	60343 7/16"
	60344 1/2"
	60345 9/16"
17	60347 5/8"
	60348 11/16"
15	60349 3/4"
13	60351 13/16"
12	60352 7/8"
10	60354 1"

■ MM

COD.	PCS.
<b>55656</b>	B
PCS./UN.	COD. PCS.
	61727 8 mm
	61729 10 mm
20	61730 11 mm
	61731 12 mm
	61732 13 mm
15	61733 14 mm
14	61734 15 mm
13	61735 16 mm
12	61736 17 mm
11	61738 19 mm

A Cromado pulido espejo / Mirror polished chrome plating / Polie chromée / Verchromt geschliffen / Cromate lucide / Cromado polido / Полированный хром  
B Cromado aerospacial / Aerspatial chrome plating / Chromée aérospatiale / Verchromt aerspatiale / Cromate satinate / Cromado fosco aerospacial / Матовый хром

Si no encuentra el artículo que necesita, consúltenos en [info@egamaster.com](mailto:info@egamaster.com) o en [www.egamaster.com](http://www.egamaster.com)  
If you can't find the item you look for, please ask us in [info@egamaster.com](mailto:info@egamaster.com) or in [www.egamaster.com](http://www.egamaster.com)  
Si vous ne trouvez pas l'article que vous desirez, consultez-nous a [info@egamaster.com](mailto:info@egamaster.com) ou a [www.egamaster.com](http://www.egamaster.com)

**LLAVES COMBINADAS EXTRA LARGAS / EXTRA-LONG COMBINATION WRENCHES / CLÉS MIXTES EXTRA-LONGUES / RINGMAULSCHLÜSSEL EXTRA LANG / CHIAVE COMBINATA EXTRA LUNGHE / CHAVES COMBINADAS EXTRA-LARGAS / КЛЮЧ КОМБИНИРОВАННЫЙ УДЛИНЕННЫЙ**

MM

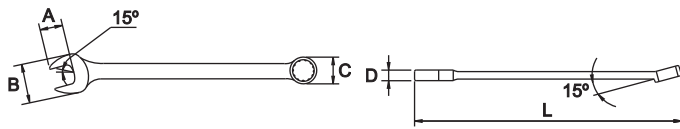

COD.	L (mm)	AF mm	A (mm)	B (mm)	C (mm)	D (mm)	g		
56405	130	6		14	11	5	18		
56406	140	7	7	15	12	5,5	20		
56407	150	8		18	14	6	30		
56408	160	9	10	20	15	6,5	35		
56409	170	10	11	22	16	7	50		
56410	180	11	12	24	18	7,5	55		
56411	195	12	14	26	19	8	65		
56412	210	13	15	27	21	8,5	95		
56413	220	14		30	22	9,5	115	10	
56414	230	15	16	32	23	10	120		
56415	240	16		34	24	11	160		
56416	250	17	18	37	27	12	190		
56417	270	18		38	28		195		
56418	280	19	21	40	29		260		B
56419	290	20	23	42	30	13	300		
56420	300	21	24	43		14	320		
56421	310	22	25	45			330		
56422	330	23		46	34	15	380		
56423	340	24	26	50	36	16	450		
56424	350	25		53	37	17			
56425	370	26	29	54	38		530		
56426		27		56	40	18		5	
56427	390	28	32	57	41	19	760		
56428	410	29		59	43		820		
56429	420	30	33	60	44	20	820		
56430	440	32	34	65	47	21	1000		

DIN 3113

**CARACTERÍSTICAS / FEATURES / CARACTÉRISTIQUES**

Cr-V

INCH

COD.	L (mm)	AF inch	A (mm)	B (mm)	C (mm)	D (mm)	g		
56432	280	3/4		40	29	8,5	260		
56433	300	13/16	21	43	32	9	320	10	
56434	310	7/8	22	45	33	9,5	330		
56435	340	15/16	24	50	36	10	440		
56436	350	1	25	53	37	11	530		A
56437	390	1.1/16	27	56	40	12	760	5	
56438	410	1.1/8	29	59	43	13	760		
56439	440	1.1/4	32	65	47	14	1000		

DIN 3113

**CARACTERÍSTICAS / FEATURES / CARACTÉRISTIQUES**

Cr-V

**A** Cromado pulido espejo / Mirror polished chrome plating / Polie chromée / Verchromt geschliffen / Cromate lucide / Cromado polido / Полированный хром

**B** Cromado aeroespacial / Aerospaceal chrome plating / Chromée aérospatiale / Verchromt aérospatiale / Cromate satinata / Cromado fosco aeroespacial / Матовый хром

**LLAVES COMBINADAS MAXI / MAXI COMBINATION WRENCHES / CLÉS MIXTES MAXI / MAXI RING-MUL-SCHLÜSSEL / CHIAVI COMBINATE MAXI / CHAVAS COMBINADAS MAXI / КОМБИНИРОВАННЫЕ КЛЮЧИ МАКСИ**

MM

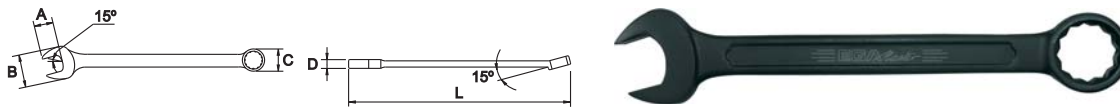

COD.	L (mm)	AF mm	A (mm)	B (mm)	C (mm)	D (mm)	Kg		
55300		70							
55301	650	75	75	145	115	24	4,2		
55302		80							
55303	700	85	85	160	120	26	5,4		
55304		90							
55305	750	95	95	180	140		7,1		
55306		100				27		1	-
55307	800	105	105	195	150		8,4		
55308		110							
55309	850	115	115	210	165		9,8		
55310		120				28			
55311	900	125	125	230	180		12,1		

INCH

COD.	L (mm)	AF inch	A (mm)	B (mm)	C (mm)	D (mm)	Kg		
55322		2.3/4							
55312	650	3	75	145	115	24	4,2		
55313		3.1/4							
55314	700	3.1/2	85	160	120	26	5,3		
55315		3.3/4							
55315	800	3.3/4	105	195	150	27	7,2		
55323		3.7/8						1	-
55316		4					8,4		
55317	850	4.1/4	115	210	165		9,8		
55318		4.1/2				28			
55319		4.3/4							
55319	900	4.3/4	125	230	180		12,1		
55320		5							

**LLAVES ACODADAS / DOUBLE OFFSET RING WRENCHES / CLÉS POLYGAONALES / RINGSCHLÜSSEL / CHIAVI POLIGONALI / CHAVES LUNETA / КЛЮЧИ ДВОЙНАЯ ИЗОГНУТАЯ ЗВЕЗДОЧКА**



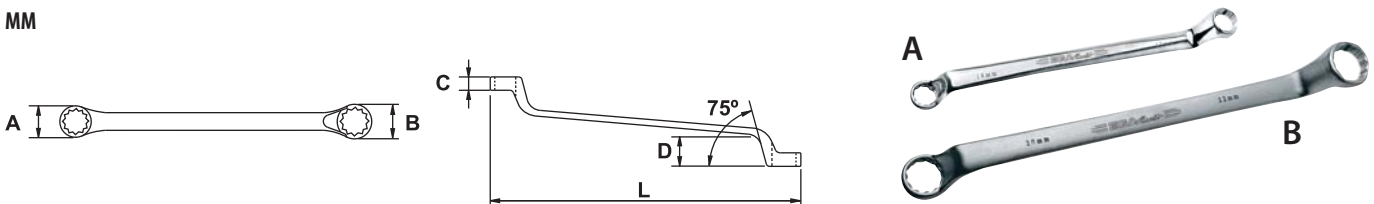

MM



COD.	COD.	L (mm)	AF mm	A (mm)	B (mm)	C (mm)	D (mm)	g		
-	61774	165	5,5-6	11	12	4,5	19	45		
61675	61775	170	6-7					50		
-	67843		7-8	13	16	6,5		55		
61676	61776	180	8-9	15	17		17	65		
-	67844		8-10			7,0		55		
61677	61777		10-11	17	19	7,5			10	•
-	67845	200	10-12					85		
-	67846		10-13				22			
-	67847	220	11-13	19	20	9,0		90		
-	67848		11-14					110		





A Cromado pulido espejo / Mirror polished chrome plating / Polie chromée / Verchromt geschliffen / Cromate lucide / Cromado polido / Полированный хром

B Cromado aeroespacial / Aerospaceal chrome plating / Chromée aérospatiale / Verchromt aerospaceal / Cromate satinate / Cromado fosco aeroespacial / Матовый хром

COD.	COD.	L (mm)		A (mm)	B (mm)	C (mm)	D (mm)			
61678	61778		12-13	19				110		
-	67849	220	12-14		21	9,0	23	120		
-	67850		13-14					125		
61679	61779	240	14-15	21	24	9,5		140		
-	67851		13-16					140		
-	67852	250	13-17		23	10		155	10	
-	67853		14-17				25	160		
61680	61780	260	16-17	25	27	11		180		
-	67854		16-18			12		200		
-	67855	290	17-19	27				220		
61681	61781		18-19	28	29			220		
-	67856		18-21					270		
-	67857	320	19-22	31	33	13	26	280	8	
61682	61782		20-22	32	34		29	360		
61683	61783		21-23	35				400		
-	67858	330	21-24		39		30	410		
-	67859		22-24	36				450		
61684	61784	340	24-26		41	15		490		
-	61788		24-27	37	42		31			
61685	61785		25-28	39	43			600		
61686	61786	350	27-29				32	600	5	
-	67860	360	27-30	41	44			650		
61687	61787	370	30-32	44	47	16	33	700		
-	67861	400	32-36		48	18	38	750		
-	67862	420	34-36	55	50	19	41	900		
61690	61789	550	36-41	70	75		49	1100		
-	67863	460	41-46	65	60	21	45	1600		
61691	61790	550	46-50	70	75	20	50	2000		

DIN 838

## INCH

COD.	L (mm)		A (mm)	B (mm)	C (mm)	D (mm)			
60380	170	1/4-5/16	10	12	5,5	18	50		
67886	180	5/16-11/32			6,0	17	55		
60381	185	5/16-3/8		16	5,5	20	65		
60382	200	3/8-7/16	14		7,0		85		
67887	220	7/16-1/2	19	20		22	90		
60383		1/2-9/16	21		9,0	24	100		
60384	240	9/16-5/8	20	23		26	125	10	
60385	260	19/32-11/16	24	25	10	27	130		
60386		5/8-11/16		27			140		
67888	290	5/8-3/4	26		13		165		
60387		11/16-3/4				30	180		
67889		11/16-13/16					240		
60388		3/4-25/32	31	30					A
60389	320	3/4-7/8			14		360		
67890		3/4-13/16		33			380		
60390		13/16-7/8	30	33		31	400		
67891	330	7/8-15/16	34	37			440		
67892	340	7/8-1.1/16					470	5	
60391	320	15/16-1	38	41					
67893	340	1-1.1/16			15				
60392	350	1-1.1/8	43			35	600		
60393		1.1/16-1.1/8		48					
60394	360	1.1/16-1.1/4	44						
67894	370	1.1/8-1.1/4		65	16		650		

DIN 838

A Cromado pulido espejo / Mirror polished chrome plating / Polie chromée / Verchromt geschliffen / Cromate lucide / Cromado polido / Полированный хром

B Cromado aeroespacial / Aerospaceal chrome plating / Chromée aérospatiale / Verchromt aérospatiale / Cromate satinato / Cromado fosco aeroespacial / Матовый хром

**CARACTERÍSTICAS / FEATURES / CARACTÉRISTIQUES**

Cr-V

■ SET

■ MM

COD.	PCS.		COD. PCS.	(mm)
<b>69252</b>	6	90056	61675, 61676, 61677, 61678, 61679, 61680	6-7, 8-9, 10-11, 12-13, 14-15, 16-17
<b>69238</b>	8	90057	61675, 61676, 61677, 61678, 61679, 61680, 61681, 61682	6-7, 8-9, 10-11, 12-13, 14-15, 16-17, 18-19, 20-22
<b>69253</b>	A 10	90058	61675, 61676, 61677, 61678, 61679, 61680, 61681, 61682, 61683, 61684	6-7, 8-9, 10-11, 12-13, 14-15, 16-17, 18-19, 20-22, 21-23, 24-26
<b>69254</b>	12	90059	61675, 61676, 61677, 61678, 61679, 61680, 61681, 61682, 61683, 61684, 61685, 61687	6-7, 8-9, 10-11, 12-13, 14-15, 16-17, 18-19, 20-22, 21-23, 24-26, 25-28, 30-32

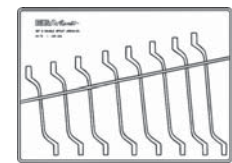

■ MM

COD.	PCS.		COD. PCS.	(mm)
<b>69255</b>	6	90056	61778, 61775, 61776, 61777, 61779, 61780	6-7, 8-9, 10-11, 12-13, 14-15, 16-17
<b>69239</b>	8	90057	61778, 61775, 61776, 61777, 61779, 61780, 61781, 61782	6-7, 8-9, 10-11, 12-13, 14-15, 16-17, 18-19, 20-22
<b>69256</b>	B 10	90058	61778, 61775, 61776, 61777, 61779, 61780, 61781, 61782, 61783, 61784	6-7, 8-9, 10-11, 12-13, 14-15, 16-17, 18-19, 20-22, 21-23, 24-26
<b>69257</b>	12	90059	61778, 61782, 61783, 61784, 61785, 61787, 61775, 61776, 61777, 61779, 61780, 61781	6-7, 8-9, 10-11, 12-13, 14-15, 16-17, 18-19, 20-22, 21-23, 24-26, 25-28, 30-32



■ INCH

COD.	PCS.		COD. PCS.	(inch)
<b>69320</b>	6	90056	60382, 60383, 60384, 60385, 60386, 60390	3/8-7/16, 1/2-9/16, 9/16-5/8, 19/32-11/16, 5/8-11/16, 13/16-7/8
<b>69321</b>	8	90057	60382, 60383, 60384, 60385, 60386, 60390, 60389, 60391	3/8-7/16, 1/2-9/16, 9/16-5/8, 19/32-11/16, 5/8-11/16, 3/4-7/8, 13/16-7/8, 15/16-1
<b>69322</b>	A 10	90058	60380, 60381, 60382, 60383, 60384, 60386, 60390, 60391, 60392, 60394	1/4-5/16, 5/16-3/8, 3/8-7/16, 1/2-9/16, 9/16-5/8, 5/8-11/16, 13/16-7/8, 15/16-1, 1-1.1/8, 1.1/16-1.1/4
<b>69323</b>	12	90059	60381, 60382, 60383, 60384, 60386, 60390, 60391, 60392, 60393, 60394, 60380, 60389	1/4-5/16, 5/16-3/8, 3/8-7/16, 1/2-9/16, 9/16-5/8, 5/8-11/16, 3/4-7/8, 13/16-7/8, 15/16-1, 1-1.1/8, 1.1/16-1.1/8, 1.1/16-1.1/4

A Cromado pulido espejo / Mirror polished chrome plating / Polie chromée / Verchromt geschliffen / Cromate lucide / Cromado polido / Полированный хром  
 B Cromado aeroespacial / Aerospaceal chrome plating / Chromée aérospatiale / Verchromt aérospatiale / Cromate satinato / Cromado fosco aeroespacial / Матовый хром

Si no encuentra el artículo que necesita, consúltenos en [info@egamaster.com](mailto:info@egamaster.com) o en [www.egamaster.com](http://www.egamaster.com)  
 If you can't find the item you look for, please ask us in [info@egamaster.com](mailto:info@egamaster.com) or in [www.egamaster.com](http://www.egamaster.com)  
 Si vous ne trouvez pas l'article que vous desirez, consultez-nous a [info@egamaster.com](mailto:info@egamaster.com) ou a [www.egamaster.com](http://www.egamaster.com)

## MM

COD.	PCS.	COD. PCS.	(mm)
68459	6	61675, 61676, 61677, 61678, 61679, 61680	6-7, 8-9, 10-11, 12-13, 14-15, 16-17
68460	8	61675, 61676, 61677, 61678, 61679, 61680, 61681, 61682	6-7, 8-9, 10-11, 12-13, 14-15, 16-17, 18-19, 20-22
68461	10	61675, 61676, 61677, 61678, 61679, 61680, 61681, 61682, 61683, 61684	6-7, 8-9, 10-11, 12-13, 14-15, 16-17, 18-19, 20-22, 21-23, 24-26



## MM

COD.	PCS.	COD. PCS.	(mm)
68463	6	61778, 61775, 61776, 61777, 61779, 61780	6-7, 8-9, 10-11, 12-13, 14-15, 16-17
68464	8	61778, 61775, 61776, 61777, 61779, 61780, 61781, 61782	6-7, 8-9, 10-11, 12-13, 14-15, 16-17, 18-19, 20-22
68465	10	61780, 61782, 61776, 61784, 61775, 61777, 61779, 61781, 61783, 61778	6-7, 8-9, 10-11, 12-13, 14-15, 16-17, 18-19, 20-22, 21-23, 24-26

## INCH

COD.	PCS.	COD. PCS.	(inch)
68471	6	60382, 60383, 60384, 60385, 60386, 60390	3/8-7/16 - 1/2-9/16 - 9/16-5/8 - 19/32-11/16 - 5/8-11/16 - 13/16-7/8
68472	8	60382, 60383, 60384, 60385, 60386, 60390, 60389, 60391	3/8-7/16, 1/2-9/16 - 9/16-5/8 - 19/32-11/16 - 5/8-11/16 - 3/4-7/8 - 13/16-7/8 - 15/16-1
68473	10	60380, 60381, 60382, 60383, 60384, 60386, 60387, 60389, 60390, 60391	1/4-5/16 - 5/16-3/8 - 3/8-7/16 - 1/2-9/16 - 9/16-5/8 - 5/8-11/16 - 11/16-3/4 - 3/4-7/8 - 13/16-7/8 - 15/16-1

## EXPOSITORES / DISPLAYS / PRESENTOIRS / DISPLAY / ESPOSITORI / DISPLAY STAND / СТЕНДЫ

## 165 PCS.

## MM



COD.	PCS.
55658	165

PCS./UN.	COD. PCS.	
20	61775	6-7 mm
	61776	8-9 mm
	61777	10-11 mm
	61778	12-13 mm
	61779	14-15 mm
15	67852	13-17 mm
14	61780	16-17 mm
13	61781	18-19 mm
12	67855	17-19 mm
11	61782	20-21 mm

## 162 PCS.

## INCH





COD.	PCS.
55659	162

PCS./UN.	COD. PCS.	
20	60380	1/4-5/16"
	60381	5/16-3/8"
	60382	3/8-7/16"
	60383	1/2-9/16"
	60384	9/16-5/8"
14	60385	19/32-11/16"
	67888	5/8-3/4"
12	60387	11/16-3/4"
	67889	11/16-13/16"
10	60390	13/16-7/8"

A Cromado pulido espejo / Mirror polished chrome plating / Polie chromée / Verchromt geschliffen / Cromate lucide / Cromado polido / Полированный хром

B Cromado aeroespacial / Aerospaceal chrome plating / Chromée aérospatiale / Verchromt aeroespaciaire / Cromate satinata / Cromado fosco aeroespacial / Матовый хром





**KIT DEMO 6 LLAVES / 6 SPANNER DEMO KIT / KIT DÉMO. 6 CLÉS / DEMOKIT 6 SCHLÜSSEL / KIT 6 CHIAVI DI DIMOSTRAZIONE / KIT DEMO 6 CHAVES / ДЕМО НАБОР 6 КЛЮЧЕЙ**

COD.	
<b>69342</b>	300
COD. PCS.	
61727	Aerospacial / Aerospacial
61627	Espejo / Mirror
73062	1000V
70172	Cu-Be
70684	Al-Bron
71669	Titanio / Titanium

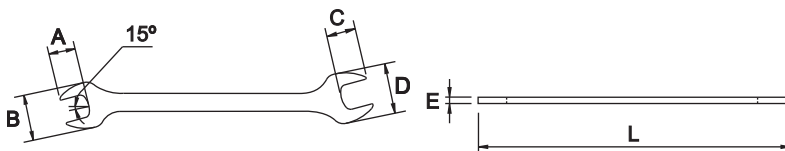
**LLAVES FIJAS EXTRAFINAS / SLIM OPEN-END WRENCHES / CLÉS À FOURCHE EXTRA-FINES / DOPPELMAULSCHLÜSSEL EXTRA DÜNN / CHIAVI FISSE EXTRAFINE / CHAVE DE BOCAS EXTRA-FINA / ТОНКИЕ РОЖКОВЫЕ КЛЮЧИ**

MM







COD.	L (mm)		A (mm)	B (mm)	C (mm)	D (mm)	E (mm)			
<b>56200</b>	150	6 x 7	7	17	8	20	2,2	21		
<b>56201</b>	175	8 x 9	9	21	10	25	2,6	40		
<b>56202</b>		10 x 11	11		12					
<b>56203</b>	210	12 x 13	13	29	14	34	3,6	85		
<b>56204</b>		14 x 15	16		17					
<b>56205</b>	250	16 x 17	18	38	18	43	4,6	170	10	●
<b>56206</b>		18 x 19	20		21					B
<b>56207</b>		20 x 22								
<b>56208</b>	290	21 x 23	24	49	26	55	5,6	330		
<b>56209</b>		22 x 24								

ISO 3318

**CARACTERÍSTICAS / FEATURES / CARACTÉRISTIQUES**

Cr-V

INCH

COD.	L (mm)		A (mm)	B (mm)	C (mm)	D (mm)	E (mm)			
<b>56210</b>	150	1/4 x 5/16	7	17	8	20	2,2	21		
<b>56211</b>	175	5/16 x 3/8		21	12	25	2,6	40		
<b>56212</b>		3/8 x 7/16	11							
<b>56213</b>	210	7/16 x 1/2	13	29	14	34	3,6	85	10	●
<b>56214</b>		1/2 x 9/16	16		17					B
<b>56215</b>	250	5/8 x 11/16	18	38	18	43	4,6	170		
<b>56216</b>		11/16 x 3/4	20		21			175		
<b>56217</b>		13/16 x 7/8	24	49	26	55	5,6	330		

ISO 3318

**CARACTERÍSTICAS / FEATURES / CARACTÉRISTIQUES**

Cr-V

**B** Cromado aeroespacial / Aerospacial chrome plating / Chromée aérospatiale / Verchromt aeroespaciale / Cromate satinata / Cromado fosco aeroespacial / Матовый хром

## ■ SET

## ■ MM

COD.	PCS.		COD. PCS.	(mm)	(inch)
<b>56226</b>	6	90056	56201, 56202, 56203, 56204, 56205, 56206	8 x 9, 10 x 11, 12 x 13, 14 x 15, 16 x 17, 18 x 19	
<b>56227</b>	B	10	90054	56200, 56201, 56202, 56203, 56204, 56205, 56206, 56207, 56208, 56209	6 x 7, 8 x 9, 10 x 11, 12 x 13, 14 x 15, 16 x 17, 18 x 19, 20 x 22, 21 x 23, 22 x 24







## ■ INCH

COD.	PCS.		COD. PCS.	(mm)	(inch)
<b>56228</b>	6	90056	56212, 56213, 56214, 56215, 56216, 56217	3/8 x 7/16 - 7/16 x 1/2 - 1/2 x 9/16 - 5/8 x 11/16 - 11/16 x 3/4 - 13/16 x 7/8	
<b>56229</b>	B	8	90081	56210, 56211, 56212, 56213, 56214, 56215, 56216, 56217	1/4 x 5/16 - 5/16 x 3/8 - 3/8 x 7/16 - 7/16 x 1/2 - 1/2 x 9/16 - 5/8 x 11/16 - 11/16 x 3/4 - 13/16 x 7/8

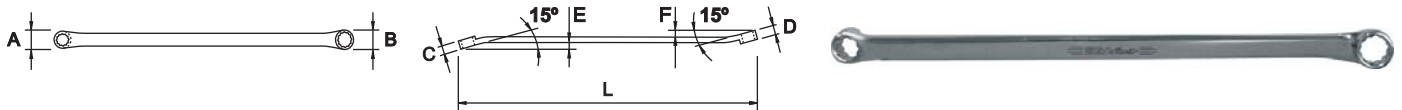
**LLAVES ESTRELLA DE DOS BOCAS EXTRAFINAS COMPENSADAS A 15° / SLIM DOUBLE RING WRENCHES 15° BENT / CLÉS POLYGONALE DOUBLE EXTRA-FINES COMPENSÉES À 15° / DOPPEL-RINGSCHLÜSSEL DÜNN 15° GEKRÖPFT / CHIAVI POLIGONALI A DUE BOCCHE A 15° / CHAVE DE LUNETAS EXTRA-FINA DE 15° / ТОНКИЕ КЛЮЧИ ДВОЙНАЯ ЗВЕЗДОЧКА С ИЗГИБОМ НА 15°**

## ■ INCH



COD.	L (mm)		A (mm)	B (mm)	C (mm)	D (mm)	E (mm)	F (mm)			
<b>56230</b>	205	7/32-1/4	11	13	6,5	8,0	4,0	4,0	50		
<b>56231</b>	235	1/4-5/16	13	16		7,5	4,5	6,0	70	10	●
<b>56232</b>	290	3/8-7/16	17	19	8,0	9,0	5,0	6,5	120		B
<b>56234</b>	330	1/2-9/16	20	22	10	11	8,0		160		

AS95E

**CARACTERÍSTICAS / FEATURES / CARACTÉRISTIQUES**





Cr-V

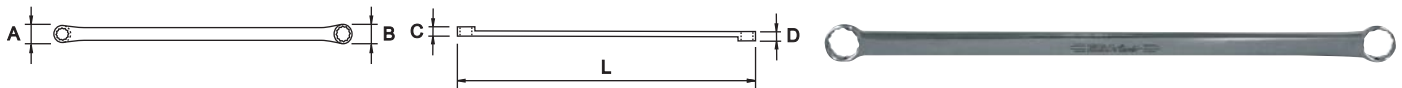

**SET**
**INCH**

COD.	PCS.		COD. PCS.	(inch)	
<b>56240</b>	B	5	90056	56230, 56231, 56232, 56233, 56234	7/32-1/4, 1/4-5/16, 5/16-3/8, 3/8-7/16, 1/2-9/16

**LLAVES ESTRELLA PLANAS DE DOS BOCAS EXTRAFINAS / SLIM FLAT DOUBLE RING WRENCHES / CLÉS POLYGAONALE PLATES DOUBLE EXTRA-FINES / DOPPEL-RINGSCHLÜSSEL DÜNN / CHIAVI POLIGONALI PIATTE A DUE BOCCHE EXTRAFINE / CHAVE DE LUNETA PLANA EXTRA-FINA / ТОНКИЕ ПЛОСКИЕ КЛЮЧИ ДВОЙНАЯ ЗВЕЗДОЧКА**
**INCH**



COD.	L (mm)		A (mm)	B (mm)	C (mm)	D (mm)			
<b>56235</b>		7/32-1/4							
<b>56236</b>	205	1/4-5/16	11	13	6.5	7.5	50		
<b>56237</b>	235	5/16-3/8	13	16		8.0	75	10	●
<b>56238</b>	290	3/8-7/16	16	19	8.0	9.0	115		B
<b>56239</b>	330	1/2-9/16	20	23	9.5	11	160		

DIN 838

**CARACTERÍSTICAS / FEATURES / CARACTÉRISTIQUES**

Cr-V

**SET**
**INCH**





COD.	PCS.		COD. PCS.	(inch)	
<b>56241</b>	B	5	90056	56235, 56236, 56237, 56238, 56239	7/32-1/4, 1/4-5/16, 5/16-3/8, 3/8-7/16, 1/2-9/16

**B** Cromado aeroespacial / Aérospatial chrome plating / Chromée aérospatiale / Verchromt aérospatiale / Cromate satinata / Cromado fosco aeroespacial / Матовый хром

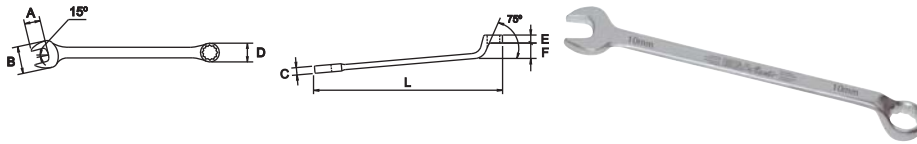
**COMBINADA ACODADA / COMBINATION DEEP OFFSET SPANNER / MIXTE CONTRE-COUDÉE / RINGMAULSCHLÜSSEL / CHIAVE COMBINATA A CONTROGOMITO / BOCA E LUNETA CONTRA-COTOVELO / КОМБИНИРОВАННЫЕ КЛЮЧИ С ГЛУБОКИМ ИЗГИБОМ**

MM



COD.	L (mm)		A (mm)	B (mm)	C (mm)	D (mm)	E (mm)	F (mm)			
60740	115	6	9,5	17	3,7	12	6,0	5,0	17		
60741	125	7	10	20	4,0	13	6,5	5,5	25		
60742	140	8				14		6,0	23		
60743	145	9	11	23	4,5	15	7,5	7,0	40		
60744	150	10	12			16	8,0	7,5	43		
60745	170	11	14	27	5,0	18	8,5	8,0	65		
60746	185	12	15	30	5,5	20	9,0	8,5			
60747	190	13	16	31		21	9,5	12	90	10	
60748	200	14	16	31	6,0	22		16	95		
60749	210	15	18	35		24	10	18	115		
60750	230	16	19	38	8,0	26			130		
60751	250	17	20	38		27	12	20	170		
60752	260	18	21	40	8,5	29		21	175		B
60753	280	19	22	43		31	13	23	240		
60755	290	21	23	46		33		24	250		
60756		22	23		9,0				270		
60757	300	23	24	47		34		25	320		
60758	320	24	26	49		36		26	350		
60759	340	25	28	50	9,5	38	14		380		
60760	350	26	28	50		38		30	420	5	
60761	360	27	29	55	10	39			410		
60762	370	28	30			42	16	32	470		
60763	380	29	32	60		45		34	550		
60764	400	30	33	65	11	46	18		600		
60765	410	32	34	70		47		35	750		

DIN 3113-B

**CARACTERÍSTICAS / FEATURES / CARACTÉRISTIQUES**

Cr-V

SET

MM

COD.	PCS.		COD. PCS.	(mm)
68568	8	90081	60742, 60743, 60744, 60745, 60746, 60747, 60748, 60751	8, 9, 10, 11, 12, 13, 14, 17
68569	12	90083	60742, 60743, 60744, 60745, 60746, 60747, 60748, 60749, 60751, 60752, 60753, 60756	8, 9, 10, 11, 12, 13, 14, 16, 17, 18, 19, 22



**ESTRELLA PLANA / DOUBLE ENDED FLAT RING SPANNER / POLYGONALE PLATE / DOPPELRINGSCHLÜSSEL / POLIGONALE DIRITTA / LUNETA DIREITA / ДВОЙНАЯ ИЗОГНУТАЯ ПЛОСКАЯ ЗВЕЗДОЧКА**

MM

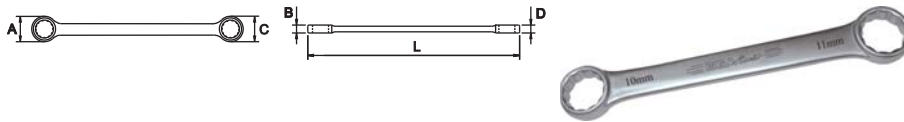

COD.	L (mm)	AP mm	A (mm)	B (mm)	C (mm)	D (mm)	g		
60770	120	6-7	12	5	11	5	25		-
60771	135	8-9	15	5,5	13	5,5	30		
60772	150	10-11	17	6,4	16	6,4	50		
60773	165	12-13	21	7	20	7	70		
60774	185	14-15	24	8	21	8	90	10	
60775	210	16-17	27	8,5	24	8,5	120		
60776	225	17-19	29	9	27	9	150		B
60777		18-19							
60778	240	20-22	34	10	31	10	200		
60779	255	21-23	35	10,5	32	10,5	240		
60780	270	24-27	39	11	37	11	300	5	
60781	285	25-28	42	13	38	13	360		
60782	335	30-32	48	14	45	14	530		

DIN 837

**CARACTERÍSTICAS / FEATURES / CARACTÉRISTIQUES**

Cr-V

SET

MM

COD.	PCS.		COD. PCS.	(mm)
68589	8	90081	60771, 60772, 60773, 60774, 60775, 60777, 60778, 60779	8-9, 10-11, 12-13, 14-15, 16-17, 18-19, 20-22, 21-23
68607	12	90083	60770, 60771, 60772, 60773, 60774, 60775, 60777, 60778, 60779, 60780, 60781, 60782	6-7, 8-9, 10-11, 12-13, 14-15, 16-17, 18-19, 20-22, 21-23, 24-27, 25-28, 30-32

**MEDIA LUNA / HALF MOON / DEMI-LUNE / STARTER BLOCKSCHLÜSSEL / A MEZZALUNA / MEIA-LUNA / ЗВЕЗДОЧКА МЕСЯЦЕМ**

MM

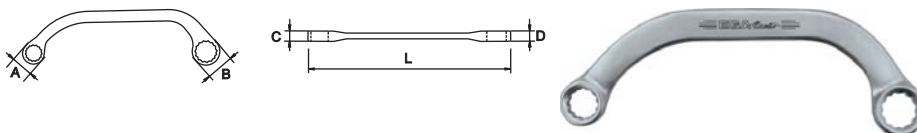

COD.	L (mm)	AP mm	A (mm)	B (mm)	C (mm)	D (mm)	g		
57158	135	6-8	15	19	8,0	8,0	55		
57159		8-10							
60795	150	11-13	20	23	9,0	9,0	90		
57160	175	13-15					110		
60796		13-17					120		
57161	185	14-16	25	28	10	10	160	10	B
60797		14-17							
57162	210	17-19	28	31	11	11	210		
60798		19-22	31				280		
57163	230	21-22	32	35	12	12	300		

DIN 475

**B** Cromado aeroespacial / Aerspatial chrome plating / Chromée aérospatiale / Verchromt aerspatiale / Cromate satinata / Cromado fosco aeroespacial / Матовый хром

**CARACTERÍSTICAS / FEATURES / CARACTÉRISTIQUES**

Cr-V

INCH

NI

COD.	L (mm)	AF inch	A (mm)	B (mm)	C (mm)	D (mm)	g		
57148	135	1/4- 5/16	15	19	8,0	8,0	55		
57149		5/16- 3/8							
57150	155	7/16- 1/2	20	23	9,0	9,0	90		
57151	185	9/16- 5/8	25	28	10	10	160	10	●
57152	210	11/16- 3/4	28	31	11	11	210		
57153	230	13/16- 7/8	32	35	12	12	300		

DIN 475

**CARACTERÍSTICAS / FEATURES / CARACTÉRISTIQUES**

Cr-V

**PARA RACORES / FLARE NUT / POLYGONALE À TUYAUTER / OFFENER DOPPELRINGSCHLÜSSEL / CHIAVE PER RACCORDI / LUNETAS ABERTAS COM BATENTE / КЛЮЧ ДЛЯ КОНИЧЕСКИХ ГАЕК**

MM



COD.	L (mm)	AF mm	A (mm)	B (mm)	C (mm)	D (mm)	E (mm)	F (mm)	g		
60785	145	8-10	19	6,0	7,5	21	7,5		45		
60786		9-11		6,5		22		9,0			
60787	150	10-11	21	7,5	9,0	23	8,5		55	10	
60788	165	11-13	22	8,5	10	25		10	100		
60789	180	12-14	25	9,5	11	28	9,0	11			
60790	210	17-19	31	14	15	34	12	13	165		●
60791	230	19-22	34	18	17	39	14	16	200		
60792	250	22-24	39	17	18	41	15		290	8	
60793	260	24-27	42	18	21	46	16	17	280		
60794	280	30-32	48	22	24	50	20	23	460	6	

DIN 3118

**CARACTERÍSTICAS / FEATURES / CARACTÉRISTIQUES**

Cr-V





SET

MM

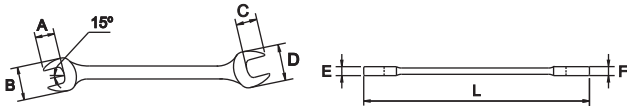
COD.	PCS.		COD. PCS.	(mm)
68587	6	90056	60785, 60788, 60789, 60790, 60792, 60793	8-10, 11-13, 12-14, 17-19, 22-24, 24-27
68588	10	90058	60785, 60786, 60787, 60788, 60789, 60790, 60791, 60792, 60793, 60794	8-10, 9-11, 10-11, 11-13, 12-14, 17-19, 19-22, 22-24, 24-27, 30-32



**FIJA / OPEN-END / À FOURCHE / DOPPELMAULSCHLÜSSEL / CHIAVE FISSE / DUAS VOCAS / РОЖКОВЫЙ КЛЮЧ**
**MM**

COD.	L (mm)		A (mm)	B (mm)	C (mm)	D (mm)	E (mm)	F (mm)			
60800	95	6-7	6,5	14	7,5	16	3,2	3,5	20		
60801	100	7-8		17	8,5	19	4,0	3,8	23		
60802	105	8-9	8,5		9,0	20		4,0	32		
60803	115	8-10	9,0	18	10	21	4,5	4,5	30		
60804		9-11		19	12	23					
60805	125	10-11		21			5,0	5,0	35		
60806		10-12	11		13	26					
60807	130	10-13		22					40		
60808		11-13				28					
60809	135	12-13		25			5,5	5,5	50		
60810	140	12-14	12		14				45		
60811		13-14		27		31			55	10	
60812		13-15		28	15			6,0	70		
60813		13-16									
60814		14-15	14			34	6,0		75		
60815	155	13-17		29	16				80		
60816		14-17						6,5			
60817	160	16-17		33	18	35			85		
60818		16-18	16	34			6,5		110		
60819		17-19			19	36			135		
60820	170	18-19		35	20	38		7,5	130		
60821		18-21				39	7,0				
60822	180	17-22	18	36		44			140		
60823	190	19-22		37	22			8,0	170		
60824	195	20-22	19	38		45			165		
60825	210	19-24	20	39		46		8,5	180		
60826		21-23	22		23	48					
60827	220	21-24		44					200		
60828		22-24	23		24	49		9,0			
60829		22-27		48	25	50			240		
60830	240	24-27	24	49	26	55		9,5	260	5	
60831	250	25-28			28				350		
60832	260	24-30	25	50		60		10	340		
60833		27-30	26	55	29						
60834	270	27-32			30	65			400		
60835		30-32	28				11	11	450		
60836	290	30-34		60	32				500		
60837		30-36	29		35	70			600		
60838	300	32-36	30	65	36		12	13	650		
60839	310	34-36	33	70	37	75			700		
60840	340	36-41	37	75	42	85	14		750		
60841	370	41-46	41	80	43	90		14	900		
60842	400	46-50		90	50	100	15		1500	1	
60843	450	50-55	48	100	55	110	16	15	1600		
60799	495	55-60		110		120	18	20	2150		
60766	580	65-70	65	140	70	140	23	23	3550		
60769	660	75-80	85	170	85	160	28	26	5600		

**DIN 895**

## ■ SET

## ■ MM





COD.	PCS.		COD. PCS.	(mm)
68585	8	90081	60802, 60805, 60809, 60814, 60817, 60820, 60826, 60828	8-9, 10-11, 12-13, 14-15, 16-17, 18-19, 21-23, 22-24
68586	12	90055	60800, 60802, 60805, 60809, 60814, 60817, 60820, 60824, 60826, 60830, 60831, 60835	6-7, 8-9, 10-11, 12-13, 14-15, 16-17, 18-19, 20-22, 21-23, 24-27, 25-28, 30-32

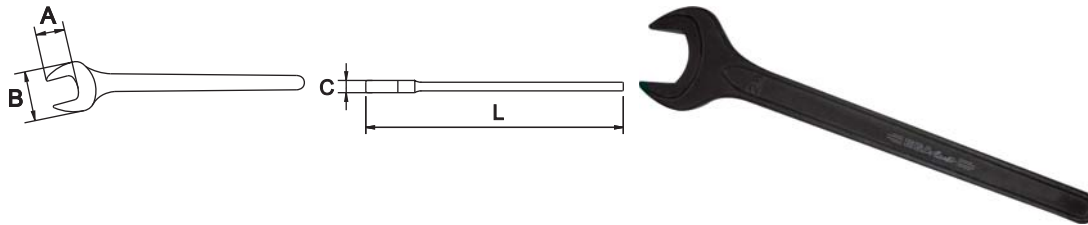

## ■ FIJA UNA BOCA / SINGLE ENDED OPEN JAW SPANNER / À FOURCHE / EINMAULSCHLÜSSEL / FISSE SEMPLICE / FIXA DE UMA BOCA / ОДНОРОЖКОВЫЙ КЛЮЧ

## ■ MM



COD.	L (mm)			A (mm)	B (mm)	C (mm)			
60844	90	8	5/16	7,0	17	3,8	15		
60845	100	9	-	9,5	20	3,9	18		
60846	105	10	-	11	22	4,5	20		
60847	110	11	7/16	12	23		23		
60848	125	12	-	13	25	5,5	27		
60849	130	13	-	14	28		37		
60850	140	14	9/16	15	29	6,0		10	
60851	150	15	-	16	32		42		
60852	155	16	-	16	32				
60853	160	17	-	17	34	6,5			
60854	165	18	-	18	36		60		
60855	170	19	3/4	20	39	7,5	75		
60856	180	21	-		43		100		
60857	195	22	7/8	23	45	8,5	120		
60858	210	24	-		48	9,5	140		
60859	240	27	1.1/16	27	55	10	180		
60860	260	30	1.3/16	29	60		300		
60861	270	32	-	32	65	12	310		
60862	280	34	1.11/32	33	70	13	400		
60863	300	36	-	37				5	
60864	320	38	1.1/2	41	75	14	420		
60865	340	41	1.5/8	42	85		550		
60866	370	46	1.13/16	44	90	15	800		
60867	390	50	-	50	100	16	1050		
60868	440	55	-	55	110	17	1200		
60869	470	60	2.3/8		120		1550		
60870	500	65	2.9/16		130	18			
62984	550	70	2.3/4	60	140	19	2250		
62985	600	75	-		150	20	2850		
62986		80	-		160	21	3600		
62987	650	85	-	70	170	22	3500		1
62988		90	-				4800		
62989	750	95	-	75	190	24	4600		
63848		100	-				7700		
63849	1000	105	-	105	220	29	8000		

DIN 894

■ SET

■ MM

COD.	PCS.		COD. PCS.	(mm)
<b>68608</b>	8	90081	60844, 60846, 60847, 60848, 60849, 60850, 60853, 60855	8, 10, 11, 12, 13, 14, 17, 19
<b>68609</b>	12	90083	60844, 60845, 60846, 60847, 60848, 60849, 60850, 60852, 60853, 60854, 60855, 60857	8, 9, 10, 11, 12, 13, 14, 16, 17, 18, 19, 22



■ **FIJA DE GOLPE / SLOGGING OPEN WRENCH / À FOURCHE À FRAPPER / SCHLAGMAULSCHLÜSSEL / FISSE AD IMPULSO / BOCA DE IMPACTO / УДАРНЫЙ РОЖКОВЫЙ КЛЮЧ**

■ MM

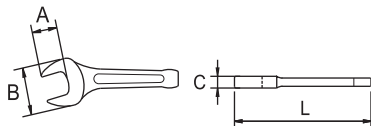

COD.	L (mm)	AF mm	A (mm)	B (mm)	C (mm)	Kg		
<b>67423</b>	125	17				0,1		
<b>67424</b>		19	19	41				
<b>67425</b>	135	21			12	0,2		
<b>67426</b>		22	22	46				
<b>60871</b>	150	24	24	50			5	●
<b>60903</b>	175	26			15	0,4		
<b>60872</b>		27						
<b>60873</b>	190	30	30	65	16	0,6		
<b>60874</b>		32	32	75				
<b>67427</b>	200	34	34	70	17	0,7		
<b>60875</b>	210	36	36	75		0,8		
<b>67428</b>	220	38	38	80	18	0,9		
<b>60876</b>	230	41	41	90		1,5		
<b>60877</b>	250	46	46	100	20			
<b>60878</b>	280	50			21			
<b>67563</b>		52	50	110				
<b>67435</b>	305	54		117		2		
<b>60879</b>	300	55	55	120	23			
<b>67436</b>	305	56		117				
<b>60880</b>	320	60	60	130		3		
<b>60927</b>	340	65	65	140	28	5	1	-
<b>60928</b>	370	70	70	160	29	6		
<b>60929</b>	380	75	75	175	32	7		
<b>60930</b>	400	80				10		
<b>60931</b>		85	85	175		11		
<b>60932</b>	450	90	95	195	36			
<b>60933</b>		95						
<b>60934</b>	490	100	105		43	14		
<b>60935</b>		105						
<b>60936</b>	500	110		230	45	19		
<b>60937</b>		115	115					
<b>60938</b>		120						
<b>67429</b>	550	125	125	250	50			

COD.	L (mm)	AF mm	A (mm)	B (mm)	C (mm)	Kg		
<b>67430</b>		130						
<b>67431</b>	550	135	135	270	50	19		
<b>67432</b>		140	145					
<b>67433</b>	650	145	150	290	55	24		
<b>67434</b>		150	150					
<b>57050</b>	645	155	160	310	60	27		
<b>57051</b>		160						
<b>57052</b>	705	165	170	330	65	30	1	-
<b>57053</b>		170						
<b>57054</b>	720	175	180	350		33		
<b>57055</b>		180						
<b>57056</b>	755	185	190	370		39		
<b>57057</b>		190						
<b>57058</b>	760	195	200	390	70	46		
<b>57059</b>		200				50		

DIN 133

**INCH**

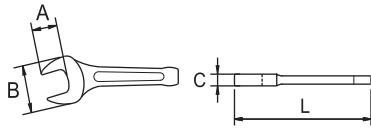

COD.	L (mm)	AF inch	A (mm)	B (mm)	C (mm)	Kg		
67437	125	3/4		41	7	0,1		
67438	135	7/8	12	47		0,2		
67439	150	15/16		50	8			
60966		1				0,4	5	•
60967	165	1.1/16	14	60	9			
67440		1.1/8				0,5		
60968		1.3/16						
60969	190	1.1/4	16	70	10	0,6		
67441		1.5/16						
67442	210	1.3/8	17	75		0,7		
67443		1.7/16						
67444	220	1.1/2	18	80	12	0,8		
67445		1.9/16						
60970	230	1.5/8	19	90		0,9		
67446		1.11/16						
67447		1.3/4						
60971	250	1.13/16	20	100	13	1,2		
67448		1.7/8						
67449		1.15/16						
60972	280	2	21	110		1,4		
67450		2.1/16			14			
67451	310	2.1/8	23	120		1,8		
67452		2.3/16						
67453		2.1/4						
67454		2.5/16		130	15	2,1		
60973		2.3/8						
67455	320	2.7/16	24					
67456		2.1/2						
60974		2.9/16		135	16	2,9	1	-
67457		2.5/8						
67458		2.11/16						
60975	330	2.3/4	26	140	17	3,6		
67459		2.13/16						
67460		2.7/8						
60976	340	2.15/16	28	150	18	4		
60977		3						
67461		3.1/16						
60978		3.1/8						
67462	360	3.1/4	29	160	19	5,5		
67463		3.5/16						
67464		3.3/8						
67465		3.7/16						
67466		3.1/2						
67467	400	3.9/16	33	185	22	7		
67468		3.5/8						
67469		3.11/16						
60979		3.3/4						
67470	430	3.13/16	40	200	24	11		
67471		3.7/8						

COD.	L (mm)	AF inch	A (mm)	B (mm)	C (mm)	Kg		
67472		3.15/16						
60980		4						
67473	430	4.1/16	40	200	24	11		
60981		4.1/8						
67474		4.3/16						
67475		4.1/4						
67476		4.5/16						
67477	500	4.3/8	45	240	25	14		
60982		4.1/2						
67478		4.9/16						
67479		4.5/8						
67480		4.11/16						
67481		4.3/4						
67482		4.13/16		250	27	16		
67483		4.7/8						
67484	550	4.15/16	50					
67485		5						
67486		5.1/4						
67487		5.5/16						
67488		5.3/8		270	30	18		
67489		5.1/2					1	-
67490	650	5.3/4	55	290	32	24		
67491		6						
58075		6.1/8						
58076	645	6.1/4	160	305	60	28		
58077		6.3/8						
58078		6.1/2						
58079	705	6.9/16	170	325		34		
58080		6.5/8						
58081		6.3/4			65			
58082		6.7/8						
58083	720	7	180	345		38		
58084		7.1/8						
58085		7.1/4						
58086	755	7.3/8	190	365		42		
58087		7.1/2						
58088		7.5/8			70			
58089		7.9/16						
58090	770	7.3/4	200	385		48		
58091		7.7/8						
58092		8						

**DIN 133**



**ESTRELLA DE GOLPE / SLOGGING RING / POLYGONALE À FRAPPER / SCHLAG RINGSCHLÜSSEL / POLIGONALE AD IMPULSO / LUNETA DE IMPACTO / УДАРНЫЙ КЛЮЧ  
ЗВЕЗДОЧКА**

MM



COD.	L (mm)	AF mm	A (mm)	B (mm)	C (mm)	Kg		
68927	145	17	32	12	7			
68928		19						
68929	155	22	38	13	8	0,2		
68930	165	24	42	14	9			
68931	175	27	46		10	0,3		
68932		30	50	16		0,4	5	•
68933	185	32	55		11	0,5		
68934	210	36	60	19		0,6		
68935	230	41	65	20	12	0,7		
68936	240	46	75	22	13	1		
68937	250	50	80	23		1,2		
68938		55	85	24	14	1,4		
68939	270	60	90	26	15	1,6		
68940	300	65	100	30	16	1,9		
68941	320	70	105	32	17	2,3		
68942	330	75	115	33	18	2,9		
68943	350	80	125	34	19	3,6		
68944	360	85	130	36	20	3,9		
68945	380	90	135	39	23	4,8	1	-
68946	410	100	148	43	25	5,8		
68947	450	110	170	45	28	8		
68948	480	120	180	50	30	10		
68949	510	130	200	55	31	12		
68950	520	140	210		32			
68951	570	150	220	60		14		
68952	590	160	240		33	16		

DIN 7444

INCH

COD.	L (mm)	AF inch	A (mm)	B (mm)	C (mm)	Kg		
68687	145	5/8	32	12	7			
68614		3/4				0,2		
68615	155	7/8	38	13	8			
68616	165	15/16	42	14	9			
68617		1	46		10	0,3		
68618		1.1/16						
68619		1.1/8	50	16		0,4	5	•
68620	185	1.3/16						
68621		1.1/4	55		11			
68622		1.5/16		18		0,5		
68623	210	1.3/8		19				
68624		1.7/16	60					
68625	220	1.1/2						
68626		1.9/16						
68627	230	1.5/8	65	20	12	0,7		
68628		1.11/16					1	-
68629	240	1.3/4	75	22	13	1		

COD.	L (mm)	AF inch	A (mm)	B (mm)	C (mm)	Kg		
68630		1.13/16						
68631	240	1.7/8	75	22	13			
68632		1.15/16				1		
68633	250	2	80	23				
68634		2.1/16			14			
68635		2.1/8	85	24		1,4		
68636		2.3/16						
68637	270	2.1/4						
68638		2.5/16	90	26	15	1,6		
68639		2.3/8						
68640		2.7/16						
68641		2.1/2						
68642	300	2.9/16	100	30	16	2,3		
68643		2.5/8						
68644		2.11/16						
68645	320	2.3/4	110	32	17	2,5		
68646		2.13/16						
68647		2.7/8						
68648	330	2.15/16	115	33	18	3,2		
68649		3						
68650	350	3.1/16	125	34	19	3,6		
68651		3.1/8						
68652		3.1/4						
68653	360	3.5/16	130	36	20	3,9		
68654		3.3/8						
68655	380	3.1/2	135			4,8		
68656		3.9/16						
68657		3.5/8		39	23		1	-
68658	390	3.11/16	140			5,2		
68659		3.3/4						
68660		3.13/16						
68661	410	3.7/8	150			5,8		
68662		3.15/16		43	25			
68663		4						
68664	420	4.1/16	155			6,5		
68665		4.1/8						
68666		4.3/16						
68667		4.1/4	160			8		
68668		4.5/16						
68669	450	4.3/8	45	28				
68670		4.1/2	170			9,6		
68671		4.9/16						
68672		4.5/8						
68673		4.11/16						
68674	480	4.3/4	180	50	30	11		
68675		4.13/16						
68676		4.7/8						
68677		4.15/16						
68678		5						
68679		5.1/4	200	55	31			
68680	520	5.5/16				12		
68681		5.3/8						
68682		5.1/2	210					
68683	570	5.3/4	60	32		14		
68684	590	6	220			16		

DIN 7444

MM



COD.	L (mm)	AF mm	A (mm)	B (mm)	C (mm)	Kg		
67310		17						
67311	145	18	32	12	7			
67312		19						
67313		20						
67314	155	21	38	13	8	0,2		
67315		22						
67316		23						
60881	165	24	42	14	8,5			
67317		25						
60904		26						
60882	175	27	46		9,5			
67318		28				0,3		
67319		29	50	16			5	
60883	185	30				0,4		
67320		31						
60884		32	55		11			
67321		33		18		0,5		
67322	210	34						
67323		35		19				
60885		36	60			0,6		
67324	220	37						
67325		38		20	12			
60886	225	41	65			0,7		
60887		42						
67326		45						
60888	240	46	75	22	13			
67327		47				1		
67422		48						
60889	250	50	80	23				
67328		52			14	1,2		
67329		54						
60890		55	85	24				
67330		56				1,4		
67331	270	58						
67332		59						
60891		60	90		15			
67333		61		26		1,6		
67334		62						
67335		63					1	
67336	300	64	100		16			
60939		65		30		1,9		
67337		66						
67338		67						
67339		68						
67340	320	69	110		17			
60940		70		32		2,3		
67341		71						
67342		72						
67343		73						
67499	330	74	115	33	18	2,9		
60941		75						

COD.	L (mm)	AF mm	A (mm)	B (mm)	C (mm)	Kg		
67344	330	76	115	33	18	2,9		
67345		77						
67346		78						
67347	350	79	125	34	19	3,6		
60942		80						
67348		82						
67492	360	84	130	36	20	3,9		
60943		85						
67349	380	88	135			4,8		
60944		90		39	23			
67350	390	94	145			5,2		
60945		95						
67351		98						
60946	410	100	150	43	25	5,8		
67308		102						
60947	420	105	155			6,5		
67368		108						
60948	450	110	170	45	28	8		
60949		115				9,5		
60950	480	120	180	50	30	10		
67352		125						
67353	510	130	195	55	31	12		
67354		135						
67355	520	140	210					
67356		145						
67357	570	150	220		32	14		
67358		155		60				
67359	590	160	240		33	16		
67360		165						
67361	650	170	270	65	34	25		
67362		175						
67363		180						
67364	690	185	280	70		33		
67365		190			35			
67366	710	195	300	75		36		
67367		200						

DIN 7444

INCH



COD.	L (mm)	AF inch	A (mm)	B (mm)	C (mm)	Kg		
67369	100	1/2	24	9	5	0,1		
67370	145	3/4	32	12	7			
67371	155	7/8	38	13	8	0,2		
67372	165	15/16	42	14	9			
60983	175	1	46	16	10	0,3	5	●
60984		1.1/16						
67373	185	1.1/8	50	11	0,4			
60985		1.3/16						
60986	210	1.1/4	55	18	0,5			
67374		1.5/16						
61294	220	1.3/8	60	19				
67375		1.7/16						
61295	230	1.1/2	65	20	0,7			
61296		1.9/16						
60987	240	1.5/8	75	22	13	1		
67376		1.11/16						
67377	250	1.3/4	80	23				
60988		1.13/16						
67378	270	1.7/8	90	26	15	1,6		
67379		1.15/16						
60989	300	2	100	28	16	2,3		
67380		2.1/16						
67381	320	2.1/8	110	32	17	2,5		
67382		2.3/16						
67383	330	2.1/4	115	33	18	3,2	1	-
67384		2.5/16						
60990	350	2.3/8	125	34	19	3,6		
67385		2.7/16						
67386	360	2.1/2	130	36	20	3,9		
60991		2.9/16						
67387	380	2.5/8	135	39	23	4,8		
67388		2.11/16						
60992	390	2.3/4	140	43	25	5,8		
67389		2.13/16						
67390	410	2.7/8	150	43	25	5,8		
60993		2.15/16						
60994	420	3	155			6,5		
67391		3.1/16						
60995	360	3.1/8	130	36	20	3,9		
67392		3.1/4						
67393	380	3.5/16	135	39	23	4,8		
67394		3.3/8						
67395	390	3.1/2	140	43	25	5,8		
67396		3.9/16						
67397	410	3.5/8	150	43	25	5,8		
67398		3.11/16						
60996	420	3.3/4	155			6,5		
67399		3.13/16						
67400	420	3.7/8	155			6,5		
67401		3.15/16						
60997	4							

COD.	L (mm)	AF inch	A (mm)	B (mm)	C (mm)	Kg		
67402	420	4.1/16	155	43	25	6,5		
60998		4.1/8						
67403	450	4.3/16	160	45	28	8		
67404		4.1/4						
67405	480	4.5/16	180	50	30	11		
67406		4.3/8						
60999	520	4.1/2	200	55	31	12		
67407		4.9/16						
67408	570	4.5/8	220	60	32	14	1	-
67409		4.11/16						
67410	585	4.3/4	240	58	33	16		
67411		4.13/16						
67412	645	4.7/8	265	64	34	25		
67413		4.15/16						
67414	685	5	285	70	33	33		
67415		5.1/4						
67416	710	5.5/16	295	75	36	36		
67417		5.3/8						
67418	710	5.1/2	295	75	36	36		
67419		5.3/4						
67420	565	6	220			16		
57136		6.1/8						
57139	585	6.1/4	240	58	33	16		
58055		6.3/8						
58056	645	6.1/2	265	64	34	25		
58057		6.9/16						
58058	685	6.5/8	285	70	33	33		
58059		6.3/4						
58060	710	6.7/8	295	75	36	36		
58061		7						
58062	710	7.1/8	295	75	36	36		
58063		7.1/4						
58064	710	7.3/8	295	75	36	36		
58065		7.1/2						
58066	710	7.9/16	295	75	36	36		
58067		7.5/8						
58068	710	7.3/4	295	75	36	36		
58069		7.7/8						
58070	8							

DIN 7444

**LLAVES ESTRELLA DE GOLPE DE PARED FINA / SLOGGING RING WRENCH THIN WALL / CLÉS POLYGONALES À FRAPPER À PAROI FINE / SCHLAGRINGSCHLÜSSEL DUNNWANDIG / CHIAVE POLIGONALI IMPACT PARETE FINA / CHAVES LUNETA DE PANCADA DE PAREDE FINA / КЛЮЧ НАКИДНОЙ УДАРНЫЙ ТОНКОСТЕННЫЙ**

MM



COD.	L (mm)	AF mm	A (mm)	B (mm)	C (mm)	Kg		
56300	250	27	43	16	17	0,6		
56301	256	30	47	18	19	0,75		
56302	260	32	49	19	21	1,05	5	•
56303	270	36	55	22	21	1,05		
56304	278	41	61	24	23	1,25		
56305	287	46	67	26	24	1,50		
56306	296	50	72	28	25	1,75		
56307	303	55	78	30	27	2		
56308	315	60	85	33	28	2,35		
56309	322	65	93	35	29	2,65		
56310	325	70	99	37	30	2,9		
56311	338	75	106	39	31	3,3		
56312	348	80	112	42	32	3,7		
56313	350	85	119	43		4	1	-
56314	353	90	126		33	4,25		
56315	358	95	133	44		4,6		
56316	366	100	139			4,9		
56317	375	105	147					
56318	382	110	157	45	34	6,5		
56319	390	115	163			7,2		
56320	405	120	174	47	35	8		

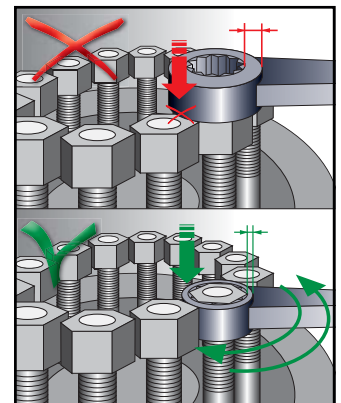

INCH

COD.	L (mm)	AF inch	A (mm)	B (mm)	C (mm)	Kg		
56321	250	1.1/16	43	16	17	0,6		
56322	260	1.1/4	49	19	21	0,75		
56323	270	1.7/16	55	22	21	1,05	5	•
56324	278	1.5/8	61	24	22.5	1,25		
56325	287	1.13/16	67	26	24	1,5		
56326	296	2	72	28	25	1,75		
56327	303	2.3/16	78	30	26.5	2		
56328	315	2.3/8	85	33	28	2,35		
56329	322	2.9/16	93	35	29	2,65		
56330	325	2.3/4	99	37	30	2,9		
56331	338	2.15/16	106	39	31	3,3	1	-
56332	348	3.1/8	112	42	32	3,7		
56333	353	3.1/2	126		33	4,25		
56334	366	3.7/8	139	44		4,9		

**LLAVE ESTRELLA DE GOLPE CURVA / CURVED SLOGGING RING WRENCH / CLÉ POLYGONALE À FRAPPER COURBÉE / ZUGSCHLAGRINGSCHLÜSSEL, GEBOGEN / POLIGONALE AD IMPULSO A CURVA / CHAVE LUNETA CURVA DE PANCADA / УДАРНЫЙ ИЗОГНУТЫЙ РОЖКОВЫЙ КЛЮЧ**

MM

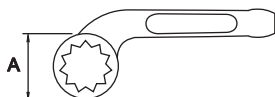

N

COD.	L (mm)	AF mm	A (mm)	B (mm)	C (mm)	Kg		
54950	140	22	42	14	9	0,2		
54951	160	24				0,3		
54952	175	27	46		10	0,4		
54953	190	30	55	16	11	0,5	1	
54954		32						
54955	210	36	60	19		0,6		
54956	230	41	65	20	12	0,9		
54957	240	46	75	22	13	1,1		
54958	260	50	80	23	14	1,3		
54959	270	55	85	24		1,5		
54960	290	60	90	26	15	2		
54961	300	65	100	30	16	2,5		
54962	320	70	110	32	17	2,8		
54963	330	75	115	33	18	3,2		

# EGGA Master

## ART IN INNOVATION

**ESTRELLA DE GOLPE ACODADA / OFFSET SLOGGING RING / CLÉ POLYGONALE À FRAPPER CONTRE- COUÉE / SCHLAGRINGSCHLÜSSEL GEKRÖPFT / CHIAVE A BATTERE POLIGONALE / LUNETA INCLINADA DE PANCADA / КЛЮЧ НАКИДНОЙ УДАРНЫЙ**

**MM**

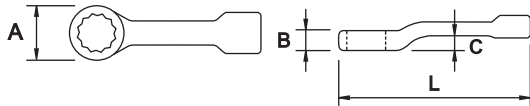

COD.	L (mm)	AF mm	A (mm)	B (mm)	C (mm)	Kg		
55000	240	22	42	18	23	0,9		
55001	240	24						
55002	270	27	50	20	26	1,2		
55003	280	30		22	28	1,4	5	•
55004	290	32	55	23	29	1,6		
55005	300	36	65	25	31	1,8		
55006	300	38						
55007	320	41	70	26	32	2		
55008	340	46		27	34	2,6		
55009	350	50	80	32	38	3		
55010	360	55	85	33	39	3,9		
55011	380	60	90	35	41	4,0		
55012	390	65	95	38	44			
55013	400	70	105	41	47	5,0		
55014	420	75	110	43	49	5,5		
55015	440	80	125	45	50	7,0		
55016	460	85				7,5		
55017	480	90	140	47		9,0	-	-
55018	480	95			55			
55019	520	100	155	49		11		
55020	520	105						
55021	550	110	170	50	60	12		
55022	550	115						
55023	590	120	180	55	64	14		
55024	590	125						
55025	620	130	200	60	70	16		
55026	620	135						

**INCH**

COD.	L (mm)	AF inch	A (mm)	B (mm)	C (mm)	Kg		
55027	240	7/8	42	18	23	0,9		
55028	240	15/16						
55029	270	1	50	20	26	1,2		
55030	270	1.1/16						
55031	280	1.1/8		22	28	1,4	5	•
55032	280	1.3/16						
55033	290	1.1/4	55	23	29	1,6		
55034	290	1.5/16						
55035	300	1.3/8	65	25	31	1,8		
55036	300	1.7/16						
55037	300	1.1/2						
55038	320	1.9/16	70	26	32	2		
55039	320	1.5/8						
55040	340	1.11/16						
55041	340	1.3/4						
55042	340	1.13/16	27	34	2,6			
55043	340	1.7/8						

COD.	L (mm)	AF inch	A (mm)	B (mm)	C (mm)	Kg		
55044	350	1.15/16	80	32	38	3		
55045	350	2						
55046	360	2.1/16						
55047	360	2.1/8	85	33	39	3,9		
55048	360	2.3/16						
55049	380	2.1/4						
55050	380	2.5/16	90	35	41	4,1		
55051	380	2.3/8						
55052	380	2.7/16						
55053	390	2.1/2						
55054	390	2.9/16	95	38	44	4,2		
55055	390	2.5/8						
55056	400	2.11/16						
55057	400	2.3/4	105	41	47	5,1		
55058	400	2.13/16						
55059	420	2.7/8						
55060	420	2.15/16	110	43	49	5,5		
55061	420	3						
55062	440	3.1/16				6,9		
55063	440	3.1/8						
55064	460	3.1/4	125	45	50	7,3		
55065	460	3.5/16						
55066	460	3.3/8						
55067	480	3.1/2						
55068	480	3.9/16						
55069	480	3.5/8	140	47		8,8		
55070	480	3.11/16						
55071	480	3.3/4						
55072	520	3.13/16			55			
55073	520	3.7/8						
55074	520	3.15/16						
55075	520	4	155	49		10,9		
55076	520	4.1/16						
55077	520	4.1/8						
55078	550	4.3/16						
55079	550	4.1/4						
55080	550	4.5/16	170	50	60	12		
55081	550	4.3/8						
55082	550	4.1/2						
55083	550	4.9/16						
55084	590	4.5/8						
55085	590	4.11/16						
55086	590	4.3/4	180	55	64	14		
55087	590	4.13/16						
55088	590	4.7/8						
55089	590	4.15/16						
55090	620	5	200	60	70	16		
55091	620	5.1/4						
55092	620	5.1/16						

**LLAVE ESTRELLA ACODADA PARA EXTENSIÓN / OFFSET RING SPANNER FOR EXTENSION / CLÉ POLYGONALE CONTRE COUDÉE À RALLONGE / RINGSCHLÜSSEL FÜR VERLÄNGERUNG / CHIAVE POLIGONALE PER ESTENSIONE / CHAVE INGLESA DESLOCADA DO ANEL PARA A EXTENSÃO / ИЗОГНУТАЯ ЗВЕЗДОЧКА ДЛЯ УДЛИНИТЕЛЯ**

MM

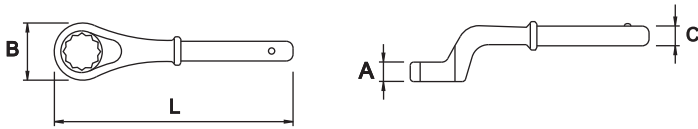

COD.	L (mm)	AF mm	A (mm)	B (mm)	C (mm)	g	
65888	180	24		38		390	
65889	190	27	17	42	18	420	
65890	200	30		48		500	
65891	230	32	18	49		750	
65892	240	36	20	55		800	
65893		38			21		
65894	260	41	21	60		950	
65895	280	46	23	70		1150	
65896	290	50	25	75	24	1350	
65897	300	55	28	80		1450	
65898	340	60	31	90		2150	1
65899	350	65	33	100		2500	
65900	360	70	36	105		2850	
65901	370	75	38	110		2050	
65902		80			29	3750	
65903	380	85	41	125		3550	
65904		90				5150	
65905	410	95	45	140		4900	
65906		100				5000	
65907	420	105		150		4900	

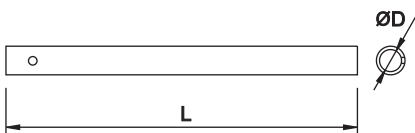

**EXTENSIÓN PARA LLAVE ESTRELLA ACODADA / EXTENSION FOR OFFSET RING SPANNER / RALLONGE DE CLÉ POLYGONALE CONTRE-COUDÉE / VERLÄNGERUNG FÜR RINGSCHLÜSSEL / ESTENSIONE PER CHIAVI POLIGONALI / EXTENSÃO PA CHAVE LUNETA CURVA / УДЛИНИТЕЛЬ ДЛЯ КЛЮЧА ИЗОГНУТАЯ ЗВЕЗДОЧКА**

COD.	AF mm	O.D. mm	L (mm)	g	
65909	24-30	18	460	750	
65910	32-41	21	600	1150	
65911	46-55	24	750	2750	1
65912	60-105	29	850	2850	

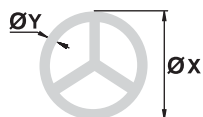

**■ LLAVE DE VÁLVULA / VALVE SPANNER / CLÉ POUR VALVE / VENTILSCHLÜSSEL / CHIAVE A VALVOLA / CHAVE DE VÁLVULA / КЛАПАНЫЙ КЛЮЧ**
**■ INCH**

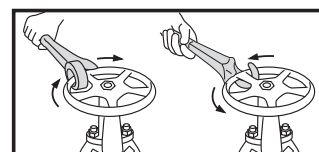
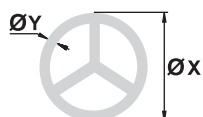
COD.	L (mm)	Ø x (inch)	Ø y (mm)	Kg	
62803	210	2-7	<= 12	0,2	1
62804	400	8-15	<= 24	1,3	
62805	490		<= 30	1,7	
62806	800	16-20	<= 30	5,5	

**■ MM**

COD.	L (mm)	Ø x (mm)	Ø y (mm)	Kg	
54972	550	125-250	<= 35	1,4	1

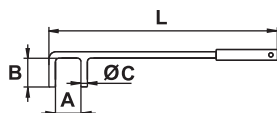
**■ GANCHO GIRADOR DE VÁLVULAS / VALVE WHEEL HOOK / FIXATION GIRATOIRE DE VALVE / VENTILHAKEN / GANCIO GIREVOLE PER VALVOLE / GANCHO DE RODA VÁLVULAS / КЛЮЧ ДЛЯ ОТКРЫТИЯ КЛАПАНОВ**
**■ MM**

COD.	L (mm)	Kg	mm	
54974	300	0,45	32	1
54975	350	0,5	45	
54976	400	0,8	50	
54977	450	1	55	
54978	500	1,2	60	
54979	550	1,4	65	
54980	600	1,5	70	
54981	650		75	
54982	700	1,6	80	
54983	750	2,3	85	
54984	800	2,4	90	
54985	850	2,5	93	
54986	900	2,6	96	
54987	950	2,8	100	
54988	1000	2,9	103	
54989	1200	5,5	105	







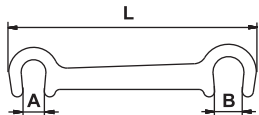

**■ LLAVE EN "C" DOBLE / DOUBLE C WRENCH / CLÉ EN DOUBLE C / DOPPEL C SCHLÜSSEL / CHIAVE DOPPIA A C / CHAVE EM C DUPLA / ДВОЙНОЙ С-ОБРАЗНЫЙ КЛЮЧ**

■ MM





COD.	L (mm)	 mm	 mm	 Kg	
54992	200	14	18	0,4	1
54993	250	17	25	0,6	
54994	450	25	34	2,3	

**■ LLAVE EN "C" / C WRENCH / CLÉ EN C / C SCHLÜSSEL / CHIAVE A C / CHAVE EM C / С-ОБРАЗНЫЙ КЛЮЧ**

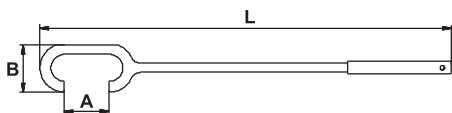
■ MM





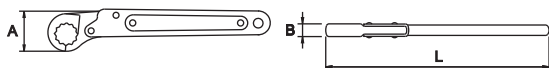

COD.	L (mm)	 mm	 Kg	
54997	450	40	1,3	1

**■ LLAVE DE CARRACA PARA RACORES / RATCHETING RING WRENCH / CLÉ À TUYAUTER À CLIQUET / KNARRENROHR SCHLÜSSEL / CHIAVE A CRICCO PER RACCORDI / CHAVE LUNETA ABERTA COM ROQUETE / КЛЮЧ ЗВЕЗДОЧКА С ТРЕЩЕТКОЙ**

■ MM



COD.	L (mm)	 mm	A (mm)	B (mm)			 g
65089	135	10	24	7,0	6	●	80
65090		11					85
65091		12					90
65092		13					140
65093	14	180	-	320			
65095	17	30			8,0		
65096	19	32			11		
65098	230	22	39	11	-	-	230
65099		24					
65100	320	27	49	13	-	-	320
65102		32					50



■ SET

■ MM

COD.	PCS.		COD.	PCS.	(mm)
68582	10	90058	65089, 65090, 65091, 65092, 65093, 65095, 65096, 65098, 65099, 65100		10, 11, 12, 13, 14, 17, 19, 22, 24, 27

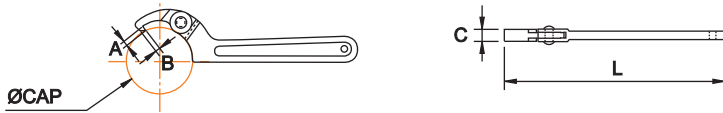

**LLAVE DE GANCHO ARTICULADA / ADJUSTABLE HOOK SPANNER / CLÉ À ERGOT ARTICULÉE / ZANGE MIT VERSTELLBARE BACKE / CHIAVE A SETTORE REGOLABILE / CHAVE DE GANCHO ARTICULADA / РУГУЛИРУЕМЫЙ КЛЮЧ КРЮК**

COD.	L (mm)	CAP. Ø (mm)	CAP. Ø (inch)	A (mm)	B (mm)	C (mm)	g	Icon 1	Icon 2
67981	160	19-50	3/4-2			9	110		
67982	205	32-75	1.1/4-3	4,0	3,5	11	225	6	•
67983	290	50-120	2-4.3/4	4,5	4,0	12	450		
67984	310	115-170	4.1/2-6.3/4	5,0	4,5	13	580		

**LLAVE DE GANCHO CON PIN ARTICULADA / ADJUSTABLE HOOK SPANNER WITH PIN / CLÉ À ERGOT ARTICULÉE AVEC CROCHET / VERSTELLBARE HAKENSCHLÜSSEL MIT PIN / CHIAVE A SETTORE ARTICOLATA CON PIN / CHAVES DE UNHA ARTICULADA COM PIN / КЛЮЧ-КРЮК С ШАРНИРОМ**

COD.	L (mm)	CAP. Ø (mm)	CAP. Ø (inch)	g	Icon 1	Icon 2
58120	170	15-35	19/32-1.3/8	100		
58121	200	35-50	1.3/8-2	180	10	
58122	280	50-80	2-3.3/4	380		•
58123	345	80-120	3.3/4-4.11/16	660		
58124	490	120-150	4.11/16-5.7/8	1440	5	

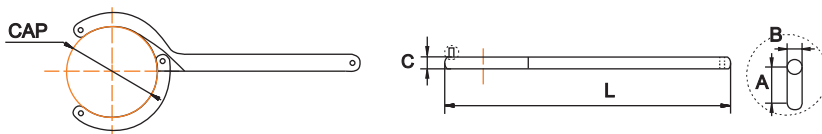

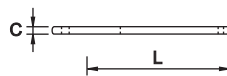
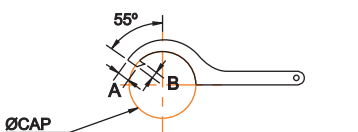

COD.	L (mm)	CAP. Ø (mm)	A (mm)	B (mm)	C (mm)	Kg	Icon 1	Icon 2
54966	150	18-40	5	4	8	0,1		
54967	220	40-80	7	5	10	0,3	6	
54968	300	80-125	8	6	12	0,6		•
54969	410	125-200	10	8	14	1,6		

**LLAVE DE GANCHO / HOOK SPANNER / CLÉ À ERGOT / ECKZANGE / CHIAVE A SETTORE / CHAVE DE GANCHO / КЛЮЧ КРЮК**



COD.	L (mm)	CAP. Ø (mm)	CAP. Ø (inch)	A (mm)	B (mm)	C (mm)	g	Icon 1	Icon 2
68283		12-14	1/2-9/16		1,8	1,8	16		
68284	110	16-20	5/8-25/32	3	2	2,3	20		
68285		25-28	1-1.1/8		2,3		40		
68286	120	30-32	1.3/16-1.1/4	4	2,5		60		
68287		34-36	1.5/16-1.13/32			2,5	90		
68288	150	40-42	1.9/16-1.21/32	5	3		100		
68289		45-50	1.3/4-2				150		
68290	180	52-55	2.1/16-2.3/16	6	3,5	3	160		
68291		58-62	2.9/32-2.7/16				210		
68292	210	68-75	2.11/16-3	7	4	3,5	250	6	•
68293		80-90	3.1/8-3.1/2				370		
68295	240	95-100	3.3/4-4	8			410		
68296		110-115	4.5/16-4.9/16		5	4	700		
68297	280	120-130	4.11/16-5.1/8	10			750		
68298		135-145	5.5/16-5.3/4				1050		
68299	320	150-165	5.7/8-6.1/2	12		6	1150		
57640		180-195	7.1/8-7.5/8	25	6		1800		
57641	380	205-220	8.1/8-8.5/8	26		14	1900		



COD.	L (mm)	CAP. Ø (mm)	CAP. Ø (inch)	A (mm)	B (mm)	C (mm)			
57642	460	230-245	9.1/8-9.5/8	30	8	16	3530		
57643		260-270	10.1/4-10.5/8				3600	6	•
57644	550	280-300	11.1/8-11.3/4	41	10		5430		

DIN 1810





**LLAVE DE GANCHO CON PIN / HOOK SPANNER WITH PIN / CLÉ À ERGOT AVEC CROCHET / HAKENSCHLÜSSEL MIT PIN / CHIAVE A SETTORE CON PIN / CHAVES DE UNHA COM PIN / КЛЮЧ-КРЮК**

COD.	L (mm)	CAP. Ø (mm)	CAP. Ø (inch)	A (mm)	B (mm)			
58100	110	16-18	5/8-11/16	2,2	2,5	25	20	
58101		20-22	25/32-7/8					
58102	135	25-28	1-1.1/8	3	3	50		
58103		30-32	1.3/16-1.1/4					
58104	170	34-36	1.5/16-1.13/32	3,5	4	80	10	
58105		40-42	1.9/16-1.21/32					
58106	205	45-50	1.3/4-2	4	5	180		
58107		52-55	2.1/16-2.3/16					
58108	240	58-62	2.9/32-2.7/16	5		280	25	•
58109		68-75	2.11/16-3					
58110	280	80-90	3.1/8-3.1/2	6		435	15	
58111		95-100	3.3/4-4					
58112	335	110-115	4.5/16-4.9/16			800	10	
58113		120-130	4.11/16-5.1/8		8			
58114	385	135-145	5.5/16-5.3/4	8		1250		
58115		155-165	5.15/16-6.1/2				5	
58116	465	180-195	7-7.11/16	10		2100		
58117		205-220	8-8.11/16					

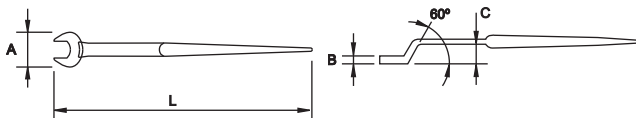
**LLAVE FIJA ACODADA PARA ESTRUCTURA / OFFSET OPEN END STRUCTURAL WRENCH / CLÉ À FOURCHE CONTRE-COUDÉE POUR STRUCTURE MÉTALLIQUE / MAULSCHLÜSSEL GEKROFFT MIT DORN / CHIAVE FISSA PER PONTEGGI / CHAVE BOCA INCLINADA PARA ESTRUTURA / КЛЮЧ ГАЕЧНЫЙ ОДНОСТОРОННИЙ ВИЛКОБРАЗНЫЙ СТРОИТЕЛЬНЫЙ**





MM



COD.	L (mm)		A (mm)	B (mm)	C (mm)			
64912		17	24	7,5		210		
64913	350	19	40	9	24	300		
64914		22	46	11		410		
64915	370	24	49		28	450		•
64916		27	55			600		
64917	400	30	65	13	32	800	1	
64918		32						
64919	430	36	70	14	36	900		
64920	470	41	80	15	41	1200		
64921	500	46	90	16	46	1500		
64922	550	50	100	17	48	1800		
64923		55	110	18	50	2000		



INCH

COD.	L (mm)		A (mm)	B (mm)	C (mm)			
64924		3/4	40	9	24	300		
64925	350	7/8	46			410		
64926		15/16		11			1	
64927	370	1	49		28	450		•
64928		1.1/16						



COD.	L (mm)	AF $\frac{\text{inch}}{\text{mm}}$	A (mm)	B (mm)	C (mm)	g		
64929		1.1/8						
64930	400	1.3/16		13	32	750		•
64931		1.1/4	65					
64932		1.5/16						
64933	430	1.3/8		14	36	900		
64934		1.7/16						
64935		1.1/2						
64936	470	1.9/16	80	15	41	1200		1
64937		1.5/8						
64938		1.11/16						
64939		1.3/4						
64940	500	1.13/16	90	16	46	1500		-
64941		1.7/8						
64942		1.15/16	100	17	48	1800		
64943		2						
64944	550	2.1/16						
64945		2.1/8	110	18	50	2000		
64946		2.3/16						

**LLAVE ESTRELLA ACODADA PARA ESTRUCTURA / OFFSET RING STRUCTURAL WRENCH / CLÉ POLYAGONALE CONTRE-COUDÉE POUR STRUCTURE MÉTALLIQUE / RINGSCHLÜSSEL GEKRÖPFT MIT DORN / CHIAVE POLIGONALE PER PONTEGGI / CHAVE LUNETA INCLINADA PARA ESTRUTURA / КЛЮЧ НАКИДНОЙ ОДНОСТОРОННИЙ ВИЛКОБРАЗНЫЙ СТРОИТЕЛЬНЫЙ**

MM

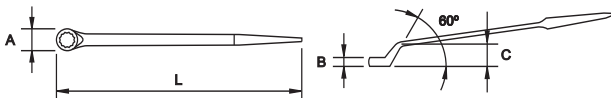

COD.	L (mm)	AF $\frac{\text{mm}}{\text{mm}}$	A (mm)	B (mm)	C (mm)	Kg		
64947	270	14	24	10	23			
64948	310	17	28	11	27	0,2		
64949	330	19	32	12	31			
64950	350	22	35	13	34	0,3		•
64951	370	24	38	14	37	0,4		
64952	400	27	42	14	37	0,4		
64953	430	30	50	16	43	0,6		
64954		32						
64955	460	36	55	19	48	0,9		
64956	490	41	65	20	55	1,1		
64957	500	46	70	22		1,5		
64958	550	50	75	26	60	1,8	1	
64959		55	85			2,1		
64960	600	60	90	28	65	2,5		
64961		65						
64962	650	70	110	30		2,7		-
64963		75		34	70	3,5		
64964		80	115	36		4,0		
64965	700	85	125	37	75			
64966		90	135	39		5,0		
64967		95	140	41				
64968	750	100	145	42	80	6,0		
64969		110	160	43		7,0		



INCH

COD.	L (mm)	AF $\frac{\text{inch}}{\text{inch}}$	A (mm)	B (mm)	C (mm)	Kg		
64970	330	3/4	32	12	31	0,2		
64971	350	7/8	35	13	34	0,3	1	•
64972	370	15/16	38					



COD.	L (mm)	AF Inch	A (mm)	B (mm)	C (mm)	Kg		
64973		1						
64974	400	1.1/16	42	14	37	0,4		
64975		1.1/8						
64976		1.3/16						
64977	430	1.1/4	50	16	43	0,6		
64978		1.5/16						
64979		1.3/8						
64980	460	1.7/16	55	19	48	0,9		
64981		1.1/2						
64982		1.9/16						
64983	490	1.5/8	65	20	50	1,0		
64984		1.11/16						
64985		1.3/4						
64986	500	1.13/16	70	22		1,5	1	
64987		1.7/8						
64988		1.15/16						
64989		2	80		60	1,8		
64990	550	2.1/16		26				
64991		2.1/8	85			2,1		
64992		2.3/16						
64993		2.1/4						
64994	600	2.5/16	90	28	65	2,5		
64995		2.3/8						
64996		2.7/16						
64997		2.1/2						
64998	650	2.9/16	105	30	70	2,7		
64999		2.5/8						

**LLAVE AJUSTABLE PARA ESTRUCTURA / ADJUSTABLE STRUCTURAL WRENCH / CLÉ À MOLETTE POUR STRUCTURE MÉTALLIQUE / VERSTELBARE ROLLGABELSCHLÜSSEL MIT DORN / CHIAVE REOLABILE PER PONTEGGI / CHAVE AJUSTÁVEL PARA ESTRUTURA / КЛЮЧ РАЗВОДНОЙ СТРОИТЕЛЬНЫЙ**

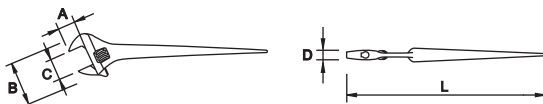

COD.	L (inch)	L (mm)	A (mm)	B (mm)	C (mm)	D (mm)	g		
61137	16	400	35	85	42	17	1100	1	



**LLAVE DE CARRACA PARA ESTRUCTURA METÁLICA / PODGING WRENCH / CLIQUET RÉVERSIBLE / STAHLBAUKNARRE / CHIAVE A CRICCO PER COSTRUZIONE / CHAVE DE ROQUETE PARA ESTRUTURA METALICA / ГОЛОВКА С ТРЕЩЕТКОЙ**

MM

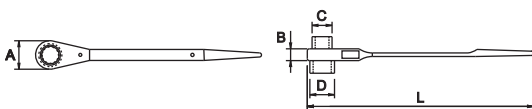

COD.	L (mm)	AF mm	A (mm)	B (mm)	C (mm)	D (mm)	g		
65916	240	10-13	28	15	15	18	170		
57545		12-14	32	16	17	20	240		
65908	280	13-17	41	17	19	24	310		
65076		17-19	43		24	27			
65917	320	19-21		19	26	28	480		
65077		19-22	50		29				
65078		19-24		20	28	33	650	6	
57546	370	22-24			31	34	750		
57547		24-27	52		34	37			
65079		24-30		21	32	41			
65080	420	27-32	60		37	43	950		
57548		30-32		22	40	44	1000		



COD.	L (mm)	AF mm	A (mm)	B (mm)	C (mm)	D (mm)	g		
57549	450	32-36	79	26	46	51	2000	6	●
65081		36-41		27	49	57			

**LLAVE DE CARRACA DOBLE VASO / DOUBLE SOCKET RATCHET WRENCH / CLÉ À CLIQUET DOUBLE DOUILLE / DOPPEL RATCHENSCHLÜSSEL / CHIAVI DOPPIE A CRICCHETTO / CHAVE DE ROQUETE DUPLA CHAVE DE SAIXA / КЛЮЧ ДВОЙНАЯ ГОЛОВКА С ТРЕЩЕТКОЙ**

MM

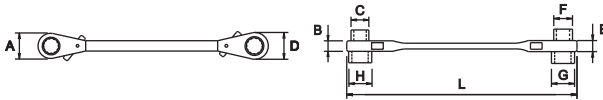

COD.	L (mm)	AF mm	A (mm)	B (mm)	C (mm)	D (mm)	E (mm)	F (mm)	G (mm)	H (mm)	g		
65104	270	14-17 x 19-21	38	17	21	42	19	27	28	24	600	2	
65105	330	17-19 x 22-24	41	19	24	50	20	30	33	27	700	1	●
65106		19-21 x 24-27	42	20	27		21	33	37	29	750		



**LLAVE ESTRELLA DE CARRACA PLANA / DOUBLE RATCHET WRENCH / CLÉ POLYGONALE À CLIQUET / DOPPELKNARRE FLACH / CHIAVE A CRICCO / CHAVE LUNETA PLANA COM ROQUETE / ДВОЙНАЯ ТРЕЩЕТКА ЗВЕЗДОЧКА**

MM

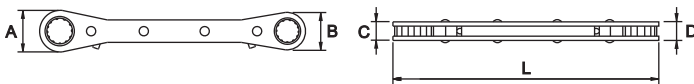

COD.	L (mm)	AF mm	A (mm)	B (mm)	C (mm)	D (mm)	g		
65107	150	8-10	18	17	9,0	9,0	90	6	
65108	170	10-11	22	19			120		
65109	180	12-13	26	21	9,5	9,5	140		●
65110	210	14-15	33	30	10		200	10	
65111		14-17		33			210		
65112	230	19-21	40	37	11	10	260		



INCH

COD.	L (mm)	AF inch	A (mm)	B (mm)	C (mm)	D (mm)	g		
65113	150	1/4-5/16	18	18	8,5	8,5	60	6	
65114	175	3/8-7/16	24	20	9,0		85		
65115	180	1/2-9/16	29	24	10	9,5	140		●
65116	210	5/8-11/16	36	33		10	200	10	
65117		3/4-7/8	40	37	11	12	260		

SET

MM

COD.	PCS.		COD. PCS.	(mm)
68610	6	90056	65107, 65108, 65109, 65110, 65111, 65112	8-10, 10-11, 12-13, 14-15, 14-17, 19-21



INCH

COD.	PCS.		COD. PCS.	(inch)
68611	5	90056	65113, 65114, 65115, 65116, 65117	1/4-5/16, 3/8-7/16, 1/2-9/16, 5/8-11/16, 3/4-7/8

**LLAVE ESTRELLA DE CARRACA ACODADA / OFFSET DOUBLE RATCHET WRENCH / CLÉ POLYGONALE CONTRE-COUDÉE À CLIQUET / DOPPELKNARRE ABGEWINKELT / CHIAVE A CRICCO A CONTROGOMITO / CHAVE LUNETA INCLINADA COM ROQUETE / ДВОЙНАЯ ТРЕЩЕТКА ЗВЕЗДОЧКА ИЗОГНУТАЯ**

MM

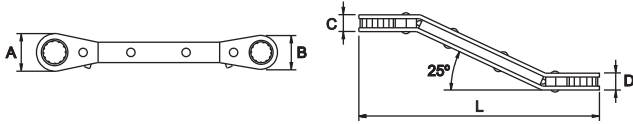

COD.	L (mm)	AF mm	A (mm)	B (mm)	C (mm)	D (mm)	g		
65118	150	8-10	20	18	9,5	9,0	85		
65119	175	10-11	25	21		9,5	120		
65120	180	12-13	29	24	10		140		●
65121	210	14-15	36	33			200		
65122	210	14-17	40	37	11	10	210	8	
65123	230	19-21	41				260		



INCH

COD.	L (mm)	AF inch	A (mm)	B (mm)	C (mm)	D (mm)	g		
65124	150	1/4-5/16	20	17	9,5	8,5	60		
65125	175	3/8-7/16	23	20		9,0	85		
65126	180	1/2-9/16	30	27	10	9,5	140		●
65127	210	5/8-11/16	36	33			200		
65128	210	3/4-7/8	40	37	10	260			



SET

MM

COD.	PCS.		COD.	PCS.	(mm)
68612	6	90056	65118, 65119, 65120, 65121, 65122, 65123		8-10, 10-11, 12-13, 14-15, 14-17, 19-21



INCH

COD.	PCS.		COD.	PCS.	(inch)
68613	5	90056	65124, 65125, 65126, 65127, 65128		1/4-5/16, 3/8-7/16, 1/2-9/16, 5/8-11/16, 3/4-7/8

**LLAVES DE PIPA ABIERTAS / ANGLED OPEN SOCKETS / CLÉS À PIPE DEBOUCHEES / PFEIFENKOPFSCHLÜSSEL / CHIAVI A PIPA APERTE / DE CACHIMBO ABERTAS / КЛЮЧ С ИЗОГНУТЫМИ ГОЛОВКАМИ**

MM

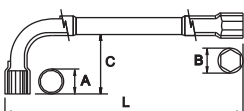

COD.	L (mm)	AF mm	AF inch	A (mm)	B (mm)	C (mm)	g		
61870	110	6	-	11	11	18	50		
61871	115	7	-	12	12	21			
61872	120	8	5/16*	13	13	22	60	6	●
61873	125	9	-	14	14	22			



A Cromado pulido espejo / Mirror polished chrome plating / Polie chromée / Verchromt geschliffen / Cromate lucide / Cromado polido / Полированный хром

COD.	L (mm)	AF mm	AF inch	A (mm)	B (mm)	C (mm)	g			
61874	130	10	25/64 *	16	16		100			
61875	135	11	7/16 *	17	17	26	140			
61876	145	12	5/32 *	18	18	27	160			
61877	150	13	-	19	19	30	170			
61878	160	14	35/64 *	21	21	33				
61879	175	15		22	22	35	230			
61880	185	16		24	24					
61881	200	17	-	25	25	39	290			
61882	210	18		26	26	41	340			
61883		19	3/4 *	28	28	44	400			
61884	220	20	25/32 *			45	470			
61885	230	21		30	30		500			
61886	245	22	-	32	32	48	600	6		A
61887	255	23	29/32 *	33	33		700			
61888	265	24		34	34	55	800			
61889	280	25	-	36	36		1000			
61890	290	26		37	37					
61891	300	27	1.1/16 *	38	38		1200			
61892	310	28	-	39	39	60				
61893	320	29	1.9/64 *	41	41		1300			
61894	330	30	1.3/16 *	42	42		1500			
61895	360	32		45	45		1800			
61768	375	34		48	48	65	2000			
61772	395	36								
61770	400	38		50	50	70	2200			

Medidas aproximadas / Approximate measurements / Mesures approximatives

DIN 475

## CARACTERÍSTICAS / FEATURES / CARACTÉRISTIQUES

12 x 6

INCH

COD.	L (mm)	AF inch	A (mm)	B (mm)	C (mm)	g			
58143	130	3/8 *	15	15	24	90			
58144	150	1/2 *	19	19	30	170			
58145	180	5/8 *	24	24	37	270			
58146	200	11/16 *	26	26	40	320		6	A
58148	245	7/8 *	34		50	650			
58147	255	15/16 *	28	34	55	660			

Medidas aproximadas / Approximate measurements / Mesures approximatives

DIN 475

## CARACTERÍSTICAS / FEATURES / CARACTÉRISTIQUES

6 x 6

MM

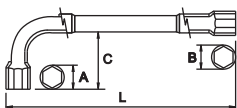

COD.	L (mm)	AF mm	AF inch	A (mm)	B (mm)	C (mm)	g			
61166		5,5	7/32 *							
61170	110	6		11	11	18	50			
61171	115	7	-	12	12	21			6	
61172	120	8	5/16 *	13	13	22	60			
61173	125	9	-	14	14		70			



A Cromado pulido espejo / Mirror polished chrome plating / Polie chromée / Verchromt geschliffen / Cromate lucide / Cromado pulido / Полированный хром



COD.	L (mm)	AF mm	AF inch	A (mm)	B (mm)	C (mm)	g		
61174	130	10	25/64 *	16	16		100		
61175	135	11	7/16 *	17	17	26	140		
61176	145	12	15/32 *	18	18	27	160		
61177	150	13	-	19	19	30	170		
61178	160	14	35/64 *	21	21	33			
61179	175	15		22	22	35	230		
61180	185	16		24	24				
61181	200	17	-	25	25	39	290		
61182	210	18		26	26	41	340		
61183		19	3/4 *	28	28	44	400		
61184	220	20	25/32 *			45	470		
61185	230	21		30	30		500		
61186	240	22	-	32	32	48	600	6	
61187	250	23	29/32 *	33	33		700		
61188	260	24		34	34	55	800		
61189	280	25	-	36	36		1000		
61190	290	26		37	37				
61191	300	27	1.1/16 *	38	38		1200		
61192	310	28	-	39	39	60			
61193	320	29	1.9/64 *	41	41		1300		
61194	330	30	1.3/16 *	42	42		1500		
61195	360	32		45	45		1800		
61769	370	34		48	48	65	2000		
61773	390	36							
61771	400	38		50	50	70	2200		

Medidas aproximadas / Approximate measurements / Mesures approximatives

**TITACROM® | DIN 475**
**CARACTERÍSTICAS / FEATURES / CARACTÉRISTIQUES**

6 x 6

**KIT-8 PCS.**
**MM**

COD.	PCS.		COD. PCS.	(mm)
68597	A	8 90057	61872, 61874, 61875, 61877, 61881, 61883, 61886, 61888	12 x 6
68598	C		61172, 61174, 61175, 61177, 61181, 61183, 61186, 61188	8-10-11-13-17-19-22-24 6 x 6

**KIT-10 PCS.**
**MM**

COD.	PCS.		COD. PCS.	(mm)
69351	A	10 90058	61872, 61873, 61874, 61875, 61876, 61877, 61878, 61881, 61883, 61885	12 x 6
69353	C		61172, 61173, 61174, 61175, 61176, 61177, 61178, 61178, 61181, 61183, 61185	8-9-10-11-12-13-14-17-19-21 6 x 6

**MM**

COD.	PCS.		COD. PCS.	(mm)
68599	A	10 90054	61872, 61874, 61875, 61876, 61877, 61878, 61880, 61881, 61882, 61883	12 x 6
68600	C		61172, 61174, 61175, 61176, 61177, 61178, 61180, 61181, 61182, 61183	8-10-11-12-13-14-16-17-18-19 6 x 6

 A Cromado pulido espejo / Mirror polished chrome plating / Polie chromée / Verchromt geschliffen / Cromate lucide / Cromado polido / Полированный хром  
 C TITACROM®

 Si no encuentra el artículo que necesita, consúltenos en [info@egamaster.com](mailto:info@egamaster.com) o en [www.egamaster.com](http://www.egamaster.com)  
 If you can't find the item you look for, please ask us in [info@egamaster.com](mailto:info@egamaster.com) or in [www.egamaster.com](http://www.egamaster.com)  
 Si vous ne trouvez pas l'article que vous désirez, consultez-nous à [info@egamaster.com](mailto:info@egamaster.com) ou à [www.egamaster.com](http://www.egamaster.com)

**KIT-15 PCS.**
**MM**

COD.	PCS.		COD. PCS.	(mm)
<b>68601</b>	A	15 90061	61872, 61874, 61875, 61876, 61877, 61878, 61879, 61880, 61881, 61882, 61883, 61885, 61886, 61887, 61888, 61888	8-10-11-12-13-14-15-16-17-18-
<b>68602</b>	C		61172, 61174, 61175, 61176, 61177, 61178, 61179, 61180, 61181, 61182, 61183, 61185, 61186, 61187, 61188	19-21-22-23-24
				12 x 6 6 x 6

**KIT-22 PCS.**
**MM**

COD.	PCS.		COD. PCS.	(mm)
<b>68603</b>	A	22 90167	61872, 61873, 61874, 61875, 61876, 61877, 61878, 61879, 61880, 61881, 61882, 61883, 61885, 61886, 61887, 61888, 61890, 61891, 61892, 61893, 61894, 61895	8-9-10-11-12-13-14-15-16-17- 18-19-21-22-23-24-26-27-28-
<b>68604</b>	C		61172, 61173, 61174, 61175, 61176, 61177, 61178, 61179, 61180, 61181, 61182, 61183, 61185, 61186, 61187, 61188, 61190, 61191, 61192, 61193, 61194, 61195	29-30-32
				12 x 6 6 x 6

**EXPOSITORES / DISPLAYS / PRESENTOIRS / DISPLAY / ESPOSITORI / DISPLAY STAND / СТЕНДЫ**
**54 PCS.**
**MM**



COD.	PCS.	A	12 x 6
<b>55570</b>	54		
PCS./UN.	COD. PCS.		
6	61872	8 mm	
	61873	9 mm	
	61874	10 mm	
	61875	11 mm	
	61876	12 mm	
	61877	13 mm	
4	61878	14 mm	
	61881	17 mm	
	61883	19 mm	
	61885	21 mm	



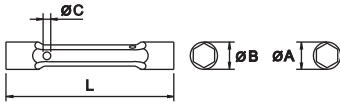

**MM**

COD.	PCS.	C	6 x 6
<b>55571</b>	54		
PCS./UN.	COD. PCS.		
6	61172	8 mm	
	61173	9 mm	
	61174	10 mm	
	61175	11 mm	
	61176	12 mm	
	61177	13 mm	
4	61178	14 mm	
	61181	17 mm	
	61183	19 mm	
	61185	21 mm	

**DE TUBO DOBLE BOCA / SOCKET DOUBLE ENDED / CLÉ À TUBE FORGÉE DROITE / DOPPEL-STECKSCHLÜSSEL / CHIAVI A TUBO / DIRITTE TUBOLARES BOCA DUPLA / ДВОЙНАЯ ГОЛОВКА**

MM



COD.	L (mm)		A (mm)	B (mm)	Ø C (mm)			
61824	105	6-7	10	11		30		
61825	110	8-9	13	14	3	50		
61826	120	10-11	15	16	5	80		
61827	140	12-13	18	19	6	140		
61828	145	14-15	20	22	6	155	10	•
61829	155	16-17	23	24	7	180		
61830	165	18-19	25	26	8	230		
61831	170	20-22	28	30		290		
61832	185	21-23	29	31	10	340		
61833	190	24-26	33	33		430		
61838	190	24-27	33	35		430		
61834	200	25-28	34	37	12	500	6	-
61835	210	27-29	37	39		550		
61836	210	30-32	40	42	13	700		





TITACROM® | DIN 896-A

**PASADOR ESCALONADO / STEP TOMMY BAR / BROCHE POUR CLÉ À TUBE / STUFEN-DREHSTIFT FÜR DOPPEL-STECKSCHLÜSSEL / PUNZONE SFALSAIO / PASSADOR ESCALONADO / ВОРОТОК СТУПЕНЧАТЫЙ**

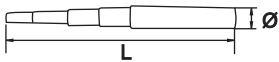
MM



COD.	L (mm)		
61794	180	2,5-4,5-5,5-6	30
61795	280	6,5-7,5-9,5-11,5-12,5-13	200





SET

MM

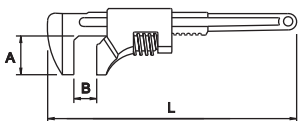
COD.	PCS.		COD.	PCS.	(mm)
69489	6	90052	61824, 61825, 61826, 61827, 61828, 61829	6	7, 8-9, 10-11, 12-13, 14-15, 16-17
69272	8	90057	61824, 61825, 61826, 61827, 61828, 61829, 61830, 61831	8	7, 8-9, 10-11, 12-13, 14-15, 16-17, 18-19, 20-22

**LLAVE DE CREMALLERA / AUTO WRENCH / CLÉ À CREMAILLÈRE / VERSTELLBARE ROHRZANGE / CHIAVE A CREMAGLIERA / CHAVE DE CREMALHEIRA / РАЗВОДНОЙ КЛЮЧ АВТОМОБИЛЬНЫЙ**

COD.	L (inch)	A (mm)	B (mm)			
61360	9	33	65	500	5	•
61361	11		80	850		
61362	15	45	85	1550	1	-



TITACROM®

**LLAVE COMBINADA ARTICULADA / FLEXIBLE COMBINATION WRENCH / CLÉ MIXTE ARTICULÉE / FLEXIBELE RINGMAULSCHLÜSSEL / CHIAVE COMBINATA ARTICOLATA / CHAVE COMBINADA ARTICULADA / КЛЮЧ КОМБИНИРОВАННЫЙ С ШАРНИРНОЙ ГОЛОВКОЙ**

MM

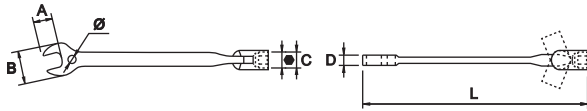

COD.	L (mm)	AF mm	A (mm)	B (mm)	C (mm)	D (mm)	O.D. mm	g		
56190	180	10	12	25	15	5,5		95		
56191	190	11	14	27	17	6		115		
56192	215	12	15	31	18	6,5	6	145	10	●
56193		13			19			150		
56194	220	14	16	32	20	8		185		
56195		15			24			230		
56196	235	17	19	38			7	320		
56197	250	19	20	41	26	9				

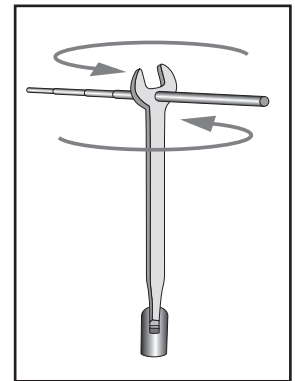
**PASADOR ESCALONADO / STEP TOMMY BAR / BROCHE POUR CLÉ À TUBE / STUFEN-DREHSTIFT FÜR DOPPEL-STECKSCHLÜSSEL / PUNZONE SFALSATO / PASSADOR ESCALONADO / ВОРОТОК СТУПЕНЧАТЫЙ**

MM



COD.	L (mm)	O.D. mm	g
61794	180	2,5-4,5-5,5-6	30
61795	280	6,5-7,5-9,5-11,5-12,5-13	200

**DE VASO DOBLE ARTICULACIÓN / DOUBLE ENDED SWIVEL / CLÉ À TUBE ARTICULÉE / DOPPEL-GELLENKSTECKSCHLÜSSEL / CHIAVE A BUSSOLA DOPPA SNODABILE / DE CAIXA ARTICULADAS / КЛЮЧ ДВОЙНАЯ ГОЛОВКА ШАРНИРНАЯ**

MM

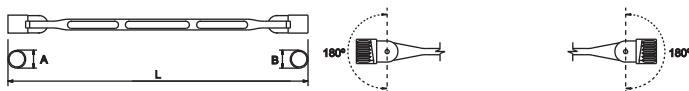



COD.	L (mm)	AF mm	A (mm)	B (mm)	g		
61301	200	8-9	12	13	100		
61302	210	10-11	15	16	110		
61303	230	12-13	19	19	155	10	
61304	240	14-15	21	21	200		
61305	250	16-17	23	24	280		
61306	270	18-19	26	26	390		
61308	290	20-22	28	30	480	5	
61309		21-23	32	32	470		
61310	330	24-27	36	36	700		



**KIT-6**
**MM**

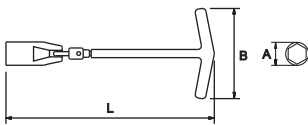

COD.	PCS.		COD. PCS.	(mm)	
<b>69185</b>	6	1,6	61301, 61302, 61303, 61304, 61305, 61306	8-9, 10-11, 12-13, 14-15, 16-17, 18-19 mm	●

**DE BUJÍA ARTICULADA / SPARK PLUG WRENCH / CLÉS À BOUGIE ART. / ZÜNDKERZENSCHLÜSSEL / CHIAVI PER CANDELE SNODABILE / CHAVE ARTICULADA PARA VELAS / СВЕЧНОЙ КЛЮЧ**

COD.	L (mm)		A (mm)	B (mm)			
<b>61471</b>	230	20-13/16	28	100	250	8	●

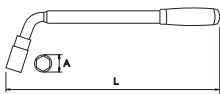



DIN 3112

**EXTENSIBLE PARA RUEDAS / EXTENSIBLE WHEEL WRENCH / CLÉS À ROUES EXTENSIBLE / AUSZIEHBARER RADMUTTERNSCHLÜSSEL / CHIAVE ESTENSIBILE PER RUOTE / EXTENSÍVEL PARA RODAS / РАЗДВИЖНОЙ БАЛОННЫЙ КЛЮЧ**
**MM**

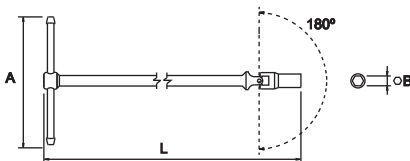
COD.		L (mm)	A (mm)		
<b>61476</b>	17-19	550	28	800	3

DIN 3112

**LLAVES ARTICULADAS EN T / T-HANDLE WRENCHES WITH UNIVERSAL JOINT / CLÉ À BEQUILLE ARTICULÉE / KARDAN GELENKSCHLÜSSEL / CHIAVE A T CON SNODO CARDANICO / CHAVES T COM CARDAN / T-ОБРАЗНЫЙ КЛЮЧ С ШАРНИРНОЙ ГОЛОВКОЙ**

COD.	L (mm)			A (mm)	B (mm)			
<b>61840</b>	390	6	-	165	10	220		
<b>61841</b>		7	-		11			
<b>61842</b>		8	5/16 *		12			
<b>61843</b>		9	11/32 *		14			
<b>61844</b>		10	-		15			
<b>61845</b>	450	11	-	180	17	420	10	●
<b>61846</b>		12	15/32 *		18			
<b>61847</b>		13	1/2 *		19			
<b>61848</b>		14	-		20			
<b>61849</b>		15	19/32 *		22			
<b>61850</b>	500	16	5/8 *	230	23	850		
<b>61851</b>		17	21/32 *		24			
<b>61852</b>		18	-		25			
<b>61853</b>		19	3/4 *		27			
<b>61854</b>		20	25/32 *		28			
<b>61855</b>	21	13/16 *	29					



COD.	L (mm)	AF mm	AF inch	A (mm)	B (mm)	g	Icon	Icon
<b>61856</b>	500	22	-	230	31	850	10	●
<b>61858</b>		24	15/16*		33			

Medidas aproximadas / Approximate measurements / Mesures approximatives

**EN CRUZ PLEGABLE / FOLDING CROSS RIM WRENCH / CLÉ EN CROIX Pliable / KREUZSCHLÜSSEL, KLAPPBAR / CHIAVE A CROCE PIEGABILE / CHAVE EM CRUZ DOBRAVEL / СКЛАДНОЙ БАЛОННЫЙ КЛЮЧ**

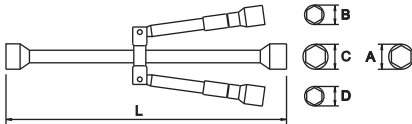

COD.	L (mm)	AF mm	A (mm)	B (mm)	C (mm)	D (mm)	g	Icon
<b>61477</b>	355	17-19-21-23	30	26	32	28	1300	1



**EN CRUZ / CROSS RIM WRENCH / CLÉ EN CROIX / KREUZSCHLÜSSEL / CHIAVE A CROCE / CHAVE DE CRUZETA / КРЕСТООБРАЗНЫЙ БАЛОННЫЙ КЛЮЧ**

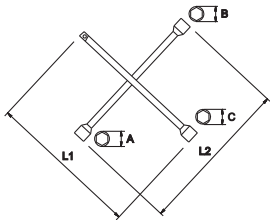

COD.	AF mm	AF inch	L1 (mm)	L2 (mm)	A (mm)	B (mm)	C (mm)	g	Icon
<b>61475</b>	17-19-22	1/2	350	350	28	26	31	1150	1

DIN 3119

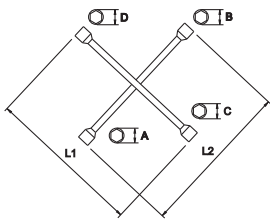

COD.	L1 (mm)	L2 (mm)	AF mm	A (mm)	B (mm)	C (mm)	g	Icon
<b>61478</b>	350	350	17-19-21-23	28	26	31	1200	1

DIN 3119



**LLAVE FIJA CROW FOOT / OPEN END CROW FOOT WRENCH / CLÉ À FOURCHE CROW FOOT / EINSTECK-MAULSCHLÜSSEL / CHIAVE FISSA CROW FOOT / PONTEIRA DE BOCA COM QUADRADO INTERIOR / РОЖКОВЫЙ КЛЮЧ С КВАДРАТОМ**

■ 1/4"

■ MM

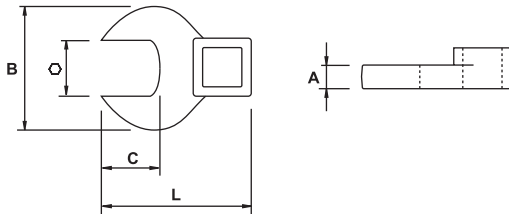

COD.	AF mm	L (mm)	A (mm)	B (mm)	C (mm)	g		
57211	7	30	6	25	6	70	10	●
57212	8	31		26	7			
57213	9	33		28	8			
57214	10	35		30	9			
57215	11	36	7	31	11	90	10	●
57216	12	38		34	12			
57217	13	39		35	13			

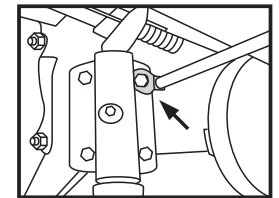

■ INCH

COD.	AF inch	L (mm)	A (mm)	B (mm)	C (mm)	g		
57218	5/16	31	6	26	7	70	10	●
57219	3/8	33		28	8			
57220	7/16	35		30	9			
57221	1/2	38		34	12			
57222	9/16	39	7	36	14	100		

# EGGA Master

## ART IN INNOVATION

## ■ 3/8"

## ■ MM

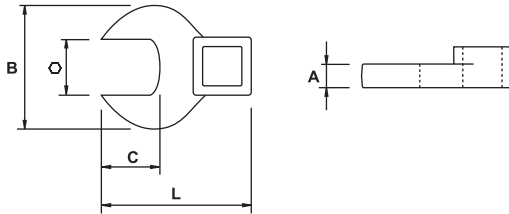

COD.	AF mm	L (mm)	A (mm)	B (mm)	C (mm)	g		
55710	10	36	6	24	10	28		
55711	11	39	6,5	26	13			
55712	12			27		35		
55713	13	40	7,2	28	14	40		
55714	14	42	8,3	30	15	41		
55715	15				16	50		
55716	16	46	8,4	34	17		10	●
55717	17	48	8,8	36	18	56		
55718	19	50	9	40	21	62		
55719	21				22,5	80		
55720	22	55	9,5	46	23,5	100		
55721	24	65	10	54	25,5	140		

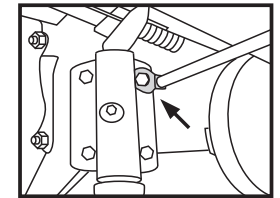

## ■ INCH

COD.	AF inch	L (mm)	A (mm)	B (mm)	C (mm)	g		
55724	3/8	36	6	24	10	28		
55725	7/16	39	6,5	26				
55726	1/2	40	7,2	28	14	40		
55727	9/16	42	8,3	30		41		
55728	5/8	46	8,4	34	17	50		
55729	11/16	48	8,8	36	18	56		
55730	3/4	50	9	40	21	62		
55731	13/16				21,5	80		
55732	7/8	55	9,5	46	22,5	100		
55733	15/16	65	10	54	25,5	140		



■ 1/2"

■ MM

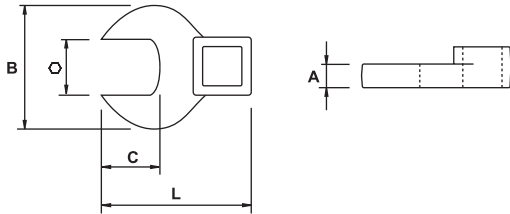

COD.	AF mm	L (mm)	A (mm)	B (mm)	C (mm)	g			
57224	20	50	12	42	19	150			
57225	21			43	20				
57226	22			45	21				
57227	23	55	12	46	22	160			
57228	24			47	23				
57229	25	60	12	49	24	185			
57230	26			50	25				190
57231	27			55	26				200
57232	28	65	12	55	27	210			
57233	29			58	28				220
57234	30	70	12	60	29	230			
57235	31			65	30				250
57236	32			70	31				260
57237	33	75	12	65	32	270	10	●	
57238	34			70	33				280
57239	35	80	14	70	34	290			
57240	36			75	35				300
57241	37			80	36				310
57242	38	85	14	75	37	320			
57243	39			80	38				330
57244	40	90	15	80	39	340			
57245	41			85	40				350
57246	42			90	41				360
57247	43	95	15	85	42	380			
57248	44			90	43				400
57249	45	100	15	90	44	430			
57250	46			95	45				460

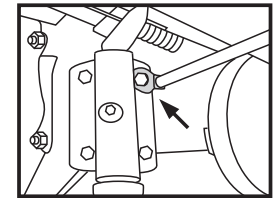

■ INCH

COD.	AF inch	L (mm)	A (mm)	B (mm)	C (mm)	g			
57251	15/16	55	12	45	21	160			
57252	1	60		47	23				
57253	1.1/16	65		50	25				190
57254	1.1/8	70	12	55	26	200			
57255	1.3/16			60	28				210
57256	1.1/4	75	12	65	30	230			
57257	1.5/16			70	31				250
57258	1.3/8			75	33				260
57259	1.7/16	80	14	70	34	270	10	●	
57260	1.1/2			75	36				280
57261	1.9/16	85	15	80	37	290			
57262	1.5/8			80	39				320
57263	1.11/16			85	41				330
57264	1.3/4	90	15	84	42	340			
57265	1.13/16			90	44				380
57266	1.7/8	95	15	90	45	400			
57267	1.15/16			95	46				430
57268	2			100	49				460
57269	2.1/16	100	15	95	49	480			

COD.	AF inch	L (mm)	A (mm)	B (mm)	C (mm)	g		
57270	2.1/8	100	15	100	50	500	10	●
57271	2.3/16					600		
57272	2.1/4	105	15	105	55	650	10	●
57273	2.5/16					700		
57274	2.3/8	110	15	110	60	750	10	●
57275	2.7/16					850		
57276	2.1/2							

**LLAVE HEXAGONAL CROW FOOT / HEXAGONAL CROW FOOT WRENCH / CLÉ MÂLE CROW FOOT / SECHSKANT-EINSTECK-MAULSCHLÜSSEL / CHIAVE ESAGONALE CROW FOOT / PONTEIRA HEXAGONAL COM QUADRADO INTERIOR / РОЖКОВЫЙ ШЕСТИГРАННЫЙ КЛЮЧ С КВАДРАТОМ**

3/8"

MM

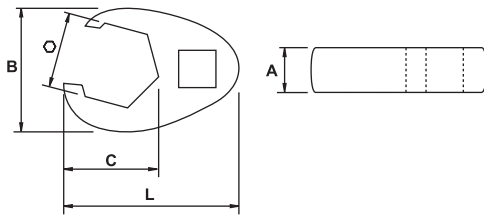

COD.	AF mm	L (mm)	A (mm)	B (mm)	C (mm)	g		
55736	10	38	7,8	31	18	28	10	●
55737	11					35		
55738	12	41	9	33	21	40	10	●
55739	13					41		
55740	14	45	10,5	36	24	50	10	●
55741	15					56		
55742	16	46	10,5	36	25	62	10	●
55743	17					80		
55744	19	50	11	40	28,5	80	10	●
55745	21					100		
55746	22							

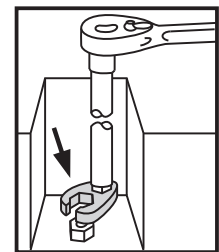

INCH

COD.	AF inch	L (mm)	A (mm)	B (mm)	C (mm)	g		
55750	3/8	38	7,8	31	18	28	10	●
55751	7/16					40		
55752	1/2	41	9	33	21	41	10	●
55753	9/16					50		
55754	5/8	46	10,5	36	25	56	10	●
55755	11/16					62		
55756	3/4	50	11	40	28,5	80	10	●
55757	13/16					100		
55758	7/8							

**ADAPTADOR DE PAR / TORQUE ADAPTER / ADAPTATEUR DE COUPLE / DREHMOMENT ADAPTOR / ADATTATORE DI COPPIA / ADAPTADOR DE PAR / АДАПТЕР КРУТЯЩЕГО МОМЕНТА**

■ 3/8"

■ MM

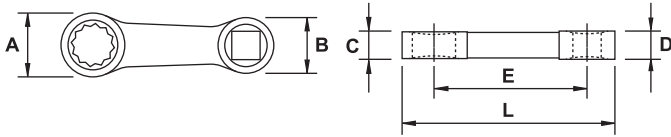

COD.	L (mm)	AF mm	AF inch	A (mm)	B (mm)	C (mm)	D (mm)	E (mm)	g	Icon 1	Icon 2
57315		8		20	19	9	12	52	51		
57316	72,5	10	3/8						61	10	●
57317		13		24		11,5					



■ INCH

COD.	L (mm)	AF inch	AF inch	A (mm)	B (mm)	C (mm)	D (mm)	E (mm)	g	Icon 1	Icon 2
57318		5/16		20	19	9	12	52	51	10	●
57319		3/8									
57320	72,5	7/16	3/8						61		
57321		1/2		24		12					
57322		9/16									



■ SPLINE

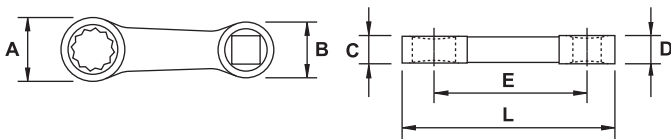

COD.	L (mm)	AF inch	AF inch	Icon 1	A (mm)	B (mm)	C (mm)	D (mm)	E (mm)	g	Icon 1	Icon 2
57323		7/32		M7								
57324		1/4		M8								
57325		9/32		M9	20		9		51			
57326		5/16		M10								
57327	72,5	3/8	3/8	M12		19		12	52	10	●	
57328		7/16		M14								
57329		1/2		M16								
57330		9/16		M18	24		12		61			
57331		5/8		M20								



**■ LLAVES HEXAGONALES / HEXAGONAL KEYS / CLÉS MÂLES / INBUSSCHLÜSSEL / CHIAVI ESAGONALI / CHAVES HEXAGONAIS / ШЕСТИГРАННИК**
**EGA**
**■ STANDARD**
**■ MM**

COD.	L (mm)	AF mm	A (mm)	g		
65302	33	0,9	10	0,2		
65955	40	1,27	12	0,9		
61501	46	1,5	14	1,0		
61502	50	2	16	2,0		
61503	60	2,5	17	3,0		
65956	55	2,7		4,5		
61504	65	3	20	5,0		
65303	70	3,5	21	7,5		
61505	75	4	25	10		
65304	80	4,5	26	14		
61506	85	5	28	15		
61507		5,5		25		
61508	95	6	32	30		
61527		7	33	45		
61509	100	8	36	60	10	●
65305	115	9	38	80		
61510	120	10	40	105		
65306	130	11	42	135		
65307	135	12		170		
65519	145	13	44	190		
65308	155	14	46	260		
65958	160	15		320		
65309	170	16	50	370		
65310	175	17		440		
65959	190	18	65	550		
65311		19		650		
65960	200	20	70			
65312	210	21		950		
65313	220	22	82			
65314	250	24	90	1250		
65961	280	27	100	1750		
65962	320	30	110	2450	5	
65963	350	32	120	3050		
65964	390	36	135	4350		
67629		38	140	4700		
67630	380	41	150	5700		
67631		46	160	7000		
67632	410	48	165	7100		
67633		50	175	9550	1	
67634	450	55	185	11200		
67635	470	60	195	14050		
67636	480	65	200	15300		
67637	500	70	210	16700		

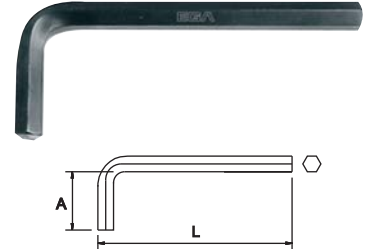

ISO 2936 | DIN 911

**CARACTERÍSTICAS / FEATURES / CARACTÉRISTIQUES**

Cr-V

## INCH

COD.	L (mm)	AF inch	A (mm)	g		
65315	46	1/16	15	0,9		
65316	50	5/64	18	2,0		
65317	60	3/32	20	3,0		
65318	65	1/8	23	5,0		
65319	75	5/32	29	10		
65320		3/16		15		
65321	85	7/32	33	25		
65322	95	1/4	38	30	10	
65323	100	5/16	44	60		•
65324	120	3/8	50	105		
65325	130	7/16	55	135		
65326	140	1/2		170		
65327	155	9/16	70	260		
65328	170	5/8	75	370		
65329	200	3/4		650		
67614	240	7/8	90	950		
67615	260	1		1250		
67616	270	1.1/8	110	1750	5	
67617	320	1.1/4	120	3050		
67618	380	1.5/8	150	5700	1	

ISO 2936 | DIN 911

## CARACTERÍSTICAS / FEATURES / CARACTÉRISTIQUES

Cr-V

## SERIE LARGA / LONG PATTERN / SÉRIE LONGUE / LANGE SERIE / SERIE LUNGA / SERIE LONGA / ДЛИННЫЙ

## MM

COD.	L (mm)	AF mm	A (mm)	g		
61517	65	1,5	15	1,0		
61518	75	2	18	2,0		
61519	85	2,5	20	4,0		
61520	95	3	23	7,0		
67298	100	3,5	25	10		
61521	105	4	29	15		
67299	115	4,5	30	19		
61522	120	5		25		
61523	130	5,5	33	35		
61524	140	6	38	40		
61557	150	7	41	60		
61525	160	8	44	80	10	
65330	170	9	47	115		
61526	180	10	50	140		•
65331	190	11		200		
65332	200	12	55	260		
67300	210	13	65	300		
67301	230	14	70	400		
67302		15		460		
67303	240	16	75	500		
67304	260	17	80	650		
67305	280	19	90	850		
67306	310	22	100	1300	1	
67307	360	24	115	1750		

ISO 2936 | DIN 911

## CARACTERÍSTICAS / FEATURES / CARACTÉRISTIQUES

Cr-V

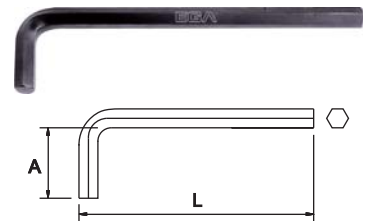

## INCH

COD.	L (mm)	AF inch	A (mm)	g		
68900		1/16	14	1,6		
68901	80	5/64	16	2,7		
68902	85	3/32	17	4,5		
68903	90	7/64	18	6,6		
68904	95	1/8	19	8,3		
68905	100	9/64	20	11		
68906	105	5/32	21	14	10	
68907	115	3/16	24	23		
68908	125	7/32	26	32		•
68909	135	1/4	29	50		
68910	150	5/16	32	80		
68911	170	3/8	35	135		
68912	190	7/16	38	210		
67671	210	1/2	43			
67672	250	5/8	50	370	6	
67653	290	3/4	55	690		
67654	350	7/8	65	1300		
67655	400	1	70	1750		
67656		1.1/8		2300		
67657	450	1.1/4	85	3750	1	-
67673	490	1.1/2	140	5800		
67658	550	1.5/8	150	7100		
67659	570	1.3/4	160	8800		

ISO 2936 | DIN 911

## CARACTERÍSTICAS / FEATURES / CARACTÉRISTIQUES

Cr-V

**BOLA SERIE LARGA / LONG PATTERN BALLPOINT / SÉRIE LONGUE À TÊTE SPHÉRIQUE / KUGELKOPF- INBUSSCHLÜSSEL / SERIE LUNGA CON TESTA SFERICA / ESFERICAS, SERIE LONGA / ДЛИННЫЙ С ШАРОВОЙ ГОЛОВКОЙ**

## MM

COD.	L (mm)	AF mm	A (mm)	g		
61615	65	1,5	15	1,0		
61616	75	2	18	2,0		
61617	85	2,5	20	3,0		
61618	95	3	23	5,0		
61619	105	4	29	10		
61620	120	5	33	15		
61621	130	5,5	33	25	10	
61622	140	6	38	30		
67493	150	7	40	60		•
61623	160	8	44	60		
67494	170	9	45	110		
61624	180	10	50	140		
67495	200	12	50	250		
67496	230	14	55	400	1	
67497	260	17	60	650		
67498	280	19	67	850		

ISO 2936 | DIN 911

## CARACTERÍSTICAS / FEATURES / CARACTÉRISTIQUES

Cr-V

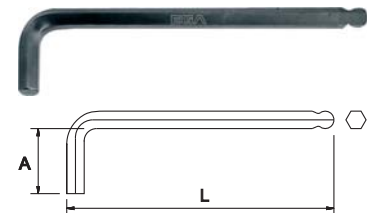

## INCH

COD.	L (mm)	AP inch	A (mm)	g		
68914	75	1/16	14	1,6		
68915	80	5/64	16	2,7		
68916	85	3/32	17	4,5		
68917	90	7/64	18	6,6		
68918	95	1/8	19	8,3		
68919	100	9/64	20	11		
68920	105	5/32	21	14	10	•
68921	115	3/16	24	23		
68922	125	7/32	26	32		
68923	135	1/4	29	50		
68924	150	5/16	32	80		
68925	170	3/8	35	135		
68926	190	7/16	38	210		

ISO 2936 | DIN 911

## CARACTERÍSTICAS / FEATURES / CARACTÉRISTIQUES

Cr-V

## ■ LLAVES TORX®\* / TORX® KEYS / CLÉS TORX®\* / TORX® INBUSSCHLÜSSEL / CHIAVI TORX®\* / CHAVES TORX®\* / КЛЮЧ TORX®\*

## ■ STANDARD

COD.	L (mm)		A (mm)	g		
67801	41	T-6	14	2,5	10	•
67802		T-7				
67803		T-8				
67804		T-9				
65333	49	T-10	16	3,5		
65334	56	T-15	17	5,0		
65335	62	T-20	19	7,5		
65336	70	T-25	20	9,5		
65337	75	T-27	24	15		
65338	85	T-30	29	20		
65339	95	T-40	34	32		
65340	110	T-45	39	44		
65341	125	T-50	41	65		

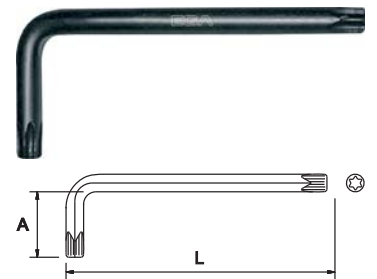



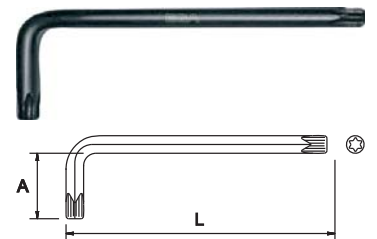

## ■ SERIE LARGA / LONG PATTERN / SÉRIE LONGUE / LANGE SERIE / SERIE LUNGA / SERIE LONGA / ДЛИННЫЙ

COD.	L (mm)		A (mm)	g		
65342	90	T-10	17	6,0		
65343	95	T-15	18	9,0		
65344	100	T-20	19	12		
65345	105	T-25	20	16		
65346	110	T-27	21	24		
65347	120	T-30	24	31		
65348	130	T-40	26	46		
65349	140	T-45	28	65		
65350	160	T-50	32	90		







\* Para tornillos TORX® (Marca registrada por Acument Intellectual Properties, LLC, Troy, Mich., US) / \*For screws TORX® (Acument Intellectual Properties, LLC, Troy, Mich., US registered trademark) / \*Pour vis TORX® (Marque enregistrée par Acument Intellectual Properties, LLC, Troy, Mich., US)

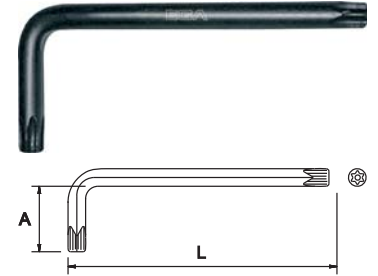



**LLAVES TAMPER TORX / TAMPER TORX KEYS / CLÉS TAMPER TORX / TAMPER TORX INBUSSCHLÜSSEL / CHIAVI TAMPER TORX / CHAVES TAMPER TORX / КЛЮЧ TAMPER TORX**

COD.	L (mm)		A (mm)			
56544	41	TT8	14	2,5		
56545		TT9				
56546	49	TT10	16	3,5		
56547	56	TT15	17	5		
56548	62	TT20	19	7,5		
56549	70	TT25	20	9,5	10	•
56550	75	TT27	24	15		
56551	85	TT30	29	20		
56552	95	TT40	34	32		
56553	110	TT45	39	44		
56554	125	TT50	41	65		

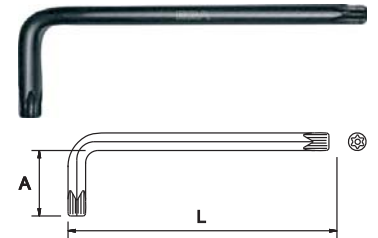
**SERIE LARGA / LONG PATTERN / SÉRIE LONGUE / LANGE SERIE / SERIE LUNGA / SERIE LONGA / ДЛИННЫЙ**

COD.	L (mm)		A (mm)			
56556	90	TT10	17	6		
56557	95	TT15	18	9		
56558	100	TT20	19	12		
56559	105	TT25	20	16		
56560	110	TT27	21	24	10	•
56561	120	TT30	24	31		
56562	130	TT40	26	46		
56563	140	TT45	28	65		
56564	160	TT50	32	90		



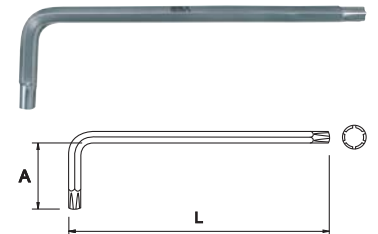

**LLAVES RIBE® / RIBE® WRENCHES / CLÉS RIBES® / RIBE® SCHLÜSSEL / CHIAVI RIBE® / CHAVES RIBE® / КЛЮЧИ RIBE®**

COD.		L (mm)	A (mm)			
65975	M4	145	22	16		
65976	M5	150	24	26		
65977	M6	160	30	42		
65978	M7	175	32	80	10	•
65979	M8	185	40	90		
65980	M10	220	55	150		











**JUEGOS / SETS / ASSORTIMENTS / SÄTZE / ASSORTIMENTI / JOGOS / НАБОРЫ**

COD.	PCS.			
<b>69987</b>	7	600	6	●
<b>Composición / Composition / Composition</b>				
65975, 65976, 65977, 65978, 65979, 65980			M4, M5, M6, M7, M8, M9, M10	





COD.	PCS.			
<b>61499</b>	8	105	12	●
<b>61500</b>	10	270		
<b>61516</b>				
<b>Composición / Composition / Composition</b>				
65315, 65316, 65317, 65318, 65319, 65320, 65321, 65322, 65323, 65324		1/16"-5/64"-3/32"-1/8"-5/32"-3/16"-7/32"-1/4"-5/16"-3/8"		





COD.	PCS.			
<b>61512</b>	7	330	12	●
<b>Composición / Composition / Composition</b>				
61519, 61520, 61521, 61522, 61524, 61525, 61526		Serie larga / Long serie		2,5-3-4-5-6-8-10 mm



COD.	PCS.			
<b>61496</b>	10	360	12	●
<b>61495</b>				
<b>Composición / Composition / Composition</b>				
68914, 68915, 68916, 68918, 68920, 68921, 68922, 68923, 68924, 68925		Serie larga / Long serie		1/16"-5/64"-3/32"-1/8"-5/32"-3/16"-7/32"-1/4"-5/16"-3/8"





COD.	PCS.		
<b>65351</b>	9	250	12
<b>Composición / Composition / Composition</b>			
65333, 65334, 65335, 65336, 65337, 65338, 65339, 65340, 65341		T10-T15-T20-T25-T27-T30-T40-T45-T50	



COD.	PCS.		
<b>65665</b>	9	300	6
<b>Composición / Composition / Composition</b>			
65342, 65343, 65344, 65345, 65346, 65347, 65348, 65349, 65350		Serie larga / Long serie	
		T10-T15-T20-T25-T27-T30-T40-T45-T50	



COD.	PCS.		
<b>65650</b>	9	250	12
<b>Composición / Composition / Composition</b>			
56546, 56547, 56548, 56549, 56550, 56551, 56552, 56553, 56554		TT10-TT15-TT20-TT25-TT27-TT30-TT40-TT45-TT50	



COD.	PCS.		
<b>56566</b>	9	300	6
Composición / Composition / Composition		Descripción / Description / Description	
56556, 56557, 56558, 56559, 56560, 56561, 56562, 56563, 56564		Serie larga / Long serie TT10-TT15-TT20-TT25-TT27-TT30-TT40-TT45-TT50	

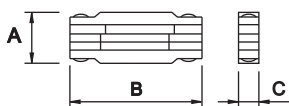

COD.	PCS.	A (mm)	B (mm)	C (mm)	Composición / Composition / Composition				
<b>61511</b>	8	39	120	32	2-2,5-3-4-5-6-8-10 mm	290	12	●	●

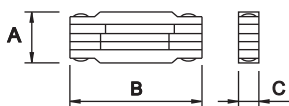

COD.	PCS.	A (mm)	B (mm)	C (mm)	Composición / Composition / Composition				
<b>61514</b>	6	21	95	32	2,5-3-4-5-6-8 mm	160	12	●	●

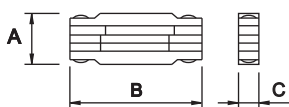

COD.	PCS.	A (mm)	B (mm)	C (mm)	Composición / Composition / Composition				
<b>61513</b>	6	33	90	17	T10-T15-T20-T25-T27-T30	90	12	●	●

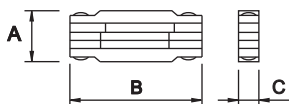

COD.	PCS.	A (mm)	B (mm)	C (mm)	Composición / Composition / Composition				
<b>56567</b>	6	33	90	17	TT10-TT15-TT20-TT25-TT27-TT30	90	12	●	●



COD.	PCS.				COD.	PCS.	Composición / Composition / Composition		
<b>65352</b>	140				-		1,5-2-2,5-3-4-5-6-8 mm	●	●
<b>65353</b>	150				65316, 65317, 65318, 65319, 65320, 65321, 65322, 65323		5/64 - 3/32 - 1/8 - 5/32 - 3/16 - 7/32 - 1/4 - 5/16	●	●
<b>65354</b>	8	12	●		67804, 65333, 65334, 65335, 65336, 65337, 65338, 65339		T9-T10-T15-T20-T25-T27-T30-T40	●	●
<b>56568</b>	140				56545, 56546, 56547, 56548, 56549, 56550, 56551, 56552		TT9-TT10-TT15-TT20-TT25-TT27-TT30-TT40	●	●

